

Sewage pipe system . Storm water pipe system

TECHNICAL MANUAL

POLO-ECO plus PREMIUM . POLO-ECO plus PREMIUM RW

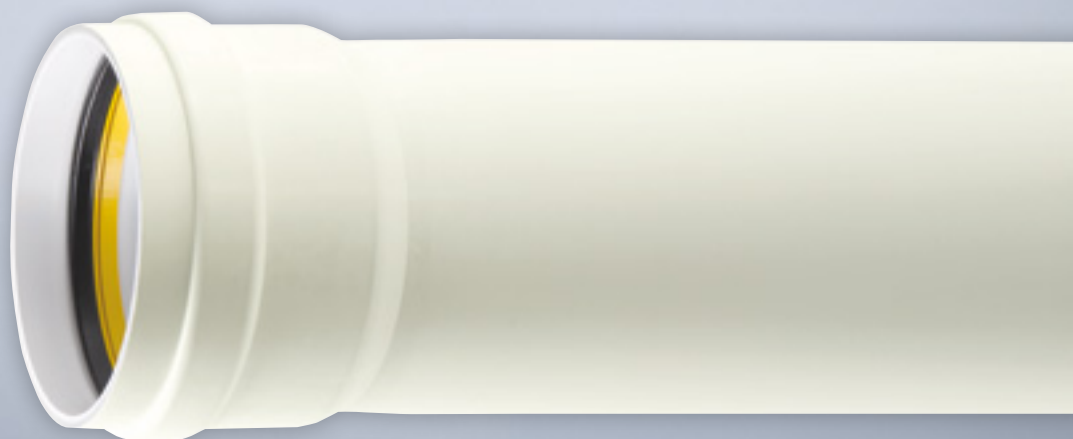

PURE
PROGRESS / **poloplast**

CONTENTS

General information

1.1	POLO-ECO plus PREMIUM 16 . 12 . 10 . POLO-ECO plus PREMIUM RW SN 16.....	5
1.2	POLO-EHP control	6
1.2.1	Simple maintenance and cleaning	6
1.2.2	Product line	6
1.2.3	Identification of storm water pipes	7
1.3	Multi-layer technology.....	8
1.3.1	Multi-layer technology for sewage systems.....	8
1.3.2	Pipes made of polypropylene	8
1.4	Environmental performance.....	9
1.4.1	The environmental performance of PP-ML pipes.....	9
1.5	Standards and approvals.....	10
1.5.1	Standards.....	10
1.5.2	Approvals	10

Material characteristics

2.1	Viscosity	11
2.1.1	Tests for resistance to point loads and toe-cracks.....	11
2.1.2	Tests for low-temperature impact strength.....	11
2.2	Abrasion strength	12
2.3	Chemical resistance	12
2.4	Resistance to de-icing salt.....	12

Product performance

3.1	Wall thickness dimensioning.....	13
3.2	Rigidity	14
3.2.1	Ring rigidity.....	14
3.2.2	Longitudinal rigidity.....	14
3.3	Longitudinal stability	15
3.3.1	Field test for proof of longitudinal stability, "bvfs" Salzburg, laying gradient 2 ‰	15
3.3.2	Longitudinal stability test by OFI – Austrian research institution in chemistry and technologies	15
3.4	Pipe rigidity and stability	17
3.5	Long-time rupture strength.....	18
3.6	Service life of more than 100 years.....	19
3.6.1	Expert opinion	19

Operational properties

4.1	Connection technique and leakproofness.....	20
4.2	High-pressure cleaning.....	20
4.3	High resistance to thermal stress.....	21

Range of products

5.1	POLO-ECO plus PREMIUM 16	22
5.1.1	Technical data	22
5.1.2	Nominal diameters – dimensions – masses	23
5.2	POLO-ECO plus PREMIUM 12	25
5.2.1	Technical data	25
5.2.2	Nominal diameters – dimensions – masses	26
5.3	POLO-ECO plus PREMIUM 10	28
5.3.1	Technical data	28

CONTENTS

5.3.2	Nominal diameters – dimensions – masses	29
5.4	POLO-ECO plus PREMIUM RW	31
5.4.1	Technical data	31
5.4.2	Nominal diameters – dimensions – masses	32
5.5	POLO-ECO plus PREMIUM . POLO-ECO plus PREMIUM RW Fittings	34
5.6	Accessories.....	42

Laying instructions

6.1	General information	43
6.1.1	Fields of application	43
6.1.2	Applicable standards	43
6.1.3	Relevant standards.....	43
6.2	Transportation and storage.....	44
6.2.1	Loading and transportation	44
6.2.2	Unloading and storage	44
6.3	Digging the utility trench	45
6.3.1	Trench depth	45
6.3.2	Trench width.....	45
6.3.3	Trench drainage.....	45
6.4	Bedding of the pipe area	46
6.4.1	Definitions.....	46
6.4.2	Lower layer of the bedding	46
6.4.3	Upper layer of the bedding	46
6.4.4	Lateral backfilling.....	47
6.4.5	Cover.....	47
6.4.6	Trench backfilling.....	47
6.4.7	Special designs	47
6.4.8	Bedding material	48
6.5	Cutting to length, bevelling, drilling	49
6.5.1	Cutting to length.....	49
6.5.2	Bevelling	49
6.5.3	Cutting to length and chamfering in one operation	49
6.5.4	Drilling of POLO-ECO plus PREMIUM Pipes.....	50
6.6	Pipe connections.....	50
6.6.1	Push-fit socket connections	50
6.6.2	Assembly options for pipes with push-fit sockets	51

Invitation to tender texts

7.1	Invitation to tender texts.....	52
7.1.1	Invitation to tender texts, Austria.....	52
7.1.2	Invitation to tender texts, Germany	52
7.1.3	Invitation to tender texts, other formats.....	52

General Information

The data contained in the present manual are to help you to select our products for your purposes. Texts and illustrations have been collated with utmost care. Nevertheless, errors cannot be ruled out entirely. POLOPLAST cannot take any kind of responsibility for incorrect information and its consequences. POLOPLAST shall be grateful for any suggestions for improvement.

For further information, please do not hesitate to contact our technical field service.
Or contact our head office at: +43 (0)732 / 38 86-0, office@poloplast.com

GENERAL INFORMATION

1.1 POLO-ECO plus PREMIUM 16 . 12 . 10 . POLO-ECO plus PREMIUM RW SN 16

The trend-setting further development of the 3-layer technology, POLO-ECO plus PREMIUM, featuring massive pipe walls and increased longitudinal stability, offers customers and engineers a wider range of possible applications while maintaining the high level of safety.



The advantages of POLO-ECO plus PREMIUM 16 . 12 . 10 . POLO-ECO plus PREMIUM RW SN 16

- **POLO-TC (TOP-CONNECT) socket system**
provides optimal laying reliability, while saving time and money
- **Very high tested longitudinal stability**
for laying pipes on extremely slight gradients $\geq 2 \text{ ‰}$
- **Lasts longer than 100 years**
confirmed by expert opinions
- **Outstanding strength properties**
thanks to the three-layer wall structure, it withstands even more difficult laying and operating loads
- **Excellent resistance to impact and abrasion**
provides long-lasting reliable functionality
- **High chemical resistance and resistance to thermal stress**
withstands even extreme stress
- **Numerous tests confirm**
its outstanding quality and fitness for use
- **Smooth pipe inner surface**
prevent deposits and incrustation and guarantee optimal hydraulic drainage
- **Wide range of fittings**
in dimensions that are in accordance with practical needs and offer tailor-made solutions
- **More than 25 years of experience in multi-layer technology**
POLOPLAST has 25 years of knowledge and experience in the tried and tested three-layer technology

GENERAL INFORMATION

1.2 POLO-EHP control

The POLO-EHP control pipe features a large cleaning aperture that fulfils all practical needs of maintenance, inspection and cleaning – the handy supplement to the POLO-ECO plus PREMIUM products.

1.2.1 Simple maintenance and cleaning

- **Simple and safe locking mechanism**
can be easily opened without tools, free from metal, does not corrode
- **The closed gutter prevents offensive odours**
a great advantage for sewage inspection
- **Large lid aperture according to EN 13598-1 and ÖNORM B2501**
a 100 × 300 mm aperture makes maintenance comfortable
- **High leakproofness under internal pressure**
high short-time and long-time leakproofness under internal pressure
- **Pressure-relieved when opened**
ensuring safe operation
- **Unchanging cross section**
no change of cross section, therefore no danger of blocking
- **System- and material-conform – halogen-free**



1.2.2 Product line

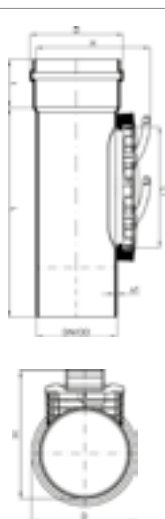

A. no.	DN/OD	L	s1 (min)	t socket	D	H	L1	kg/pc.	design	Leakproof under pressure, short-time/bar	Leakproof under pressure, long-time/bar
06590	110	468	3.6	65.0	129.2	196	301	2.3	SG	1.5	1.0
06591	125	474	4.0	73.0	146.4	222	301	2.5	SG	1.5	1.0
06592	160	488	5.1	84.0	184.8	251	301	3.2	SG	1.5	1.0
06593	200	518	7.0	120.0	230.5	295	301	4.6	SG	1.5	1.0
06594	250	680	8.5	150.0	290.0	330	301	8.5	HF	1.0	0.5
06595	315	680	10.8	180.0	362.5	400	301	13.0	HF	1.0	0.5
06596	400	1000	13.6	230.0	457.5	485	301	30.0	HF	1.0	0.5
06597	500	1000	17.1	280.0	571.0	585	301	49.0	HF	1.0	0.5

SG ... injection moulding

HF ... hand moulding

Subject to technical alterations

GENERAL INFORMATION

Efficient waste water management – demands rise

Efficient sewage management is subject to constant rationalisation. Operators need to make sure that their sewerage networks and waste water treatment plants are cost covering.

Waste water and storm water are often conveyed in joint piping and main drains to the treatment plants, where they are conditioned and then flow away as natural watercourse. These are so-called mixed systems, which entail significant disadvantages in terms of hydraulic dimensioning of the pipes and the required capacity of the waste water treatment plants.

A consequent separation of waste water and storm water in separate pipelines is a much more efficient solution. Domestic rain water, for example from gutters, and drainage water from public roads, streets and squares, is fed into separate piping. Storm water does not need to be conditioned and can be fed into the groundwater bodies or natural watercourses.

The amount of waste water of domestic origin, as well as of industrial waste water, is continuous, without significant changes. This is why waste water sewers that are separated from storm waters pipes can be designed in a hydraulically optimal way, which, in turn, has positive effects on their conveying capacity and the cleaning intervals of the pipes. Separated systems reduce the burden on the capacities of sewage plants and can be operated in parallel to existing mixed-type systems when housing estates expand.

Storm water sewers do not have a connecting pipe to cellars and the living spaces of buildings. Therefore, the sewage pipe is not in danger of becoming overloaded by heavy rainfall, and of backing up into the building and causing massive damage.

1.2.3 Identification of storm water pipes

In Germany, storm water drainage pipes must be marked unambiguously in order to rule out erroneous connections. The potential danger of swapping pipes is particularly high in the domestic area, when buildings have to be connected to public networks.

POLO-ECO plus PREMIUM RW meets these requirements perfectly.

The inner layer of the storm water pipes is painted in a well-tried, inspection-friendly light grey colour. The opal-white pipes with the blue stripes at the third points are unambiguously marked as storm water drainage pipes.

GENERAL INFORMATION

GENERAL INFORMATION

MATERIAL CHARACTERISTICS

PRODUCT PERFORMANCE

OPERATIONAL PROPERTIES

RANGE OF PRODUCTS

LAYING INSTRUCTIONS

INVITATION TO TENDER TEXTS

1.3 Multi-layer technology

1.3.1 Multi-layer technology for sewage systems

The demands placed on pipe systems in hydraulic structures for sanitary engineering purposes have significantly grown over the last years. As increasingly aggressive industrial waste water needs to be conveyed, the pipe material must at any rate maintain its service life between 50 and 80 years. High-pressure flushing has become the state-of-the-art continuous maintenance method for sewage pipe networks, which is why the pipes' inner layer must be highly resistant to abrasion and impact. Apart from that, an increasing pressure of avoiding rising costs of hydraulic structures makes it inevitable to optimize the planning of sewage systems. The results are gradients in the per mil range and low assembly depths.

These high demands in sanitary engineering require the development of new and the improvement of existing sewage pipe systems. Thanks to the multi-layer technology, plastic sewage pipes optimally meet these demands. The combination of individual layers enables all different demands placed on sewage pipes to be met.

1.3.2 Pipes made of polypropylene

For many decades, this high-grade plastic material has proved itself in the automotive industry, in medical engineering and many other industrial applications. As its excellent properties are continuously further developed, polypropylene is optimally suitable for use in sanitary engineering for hydraulic structures. In conjunction with the multi-layer technology, polypropylene ensures the maximum possible reliability for planners and converters, as well as decades of trouble-free operation. Polypropylene is the basic material for further developing, using specialized compounding methods. The material's physical parameters can be deliberately increased in a controlled way. In the case of POLO-ECO plus PREMIUM, long series of experiments were conducted in which mineral reinforcing agents were added to create a compound material with a highly rigid bearing layer and, at the same time, only moderate wall thickness values. These mineral reinforcing **agents** are so-called „**active fillers**“, which have significant positive influence on the material and pipe properties. The operational advantages in this case are larger inner diameters and consequently an increased drainage capacity.

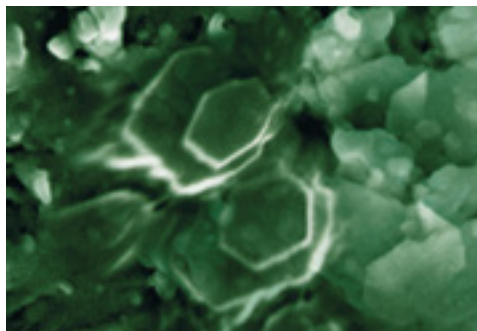

Magnesium silicate embedded in a PP matrix

GENERAL INFORMATION

1.4 Environmental performance

1.4.1 The environmental performance of PP-ML pipes

The use of polypropylene as a pipe material and the reinforcement of the inner bearing layer by a natural mineral substance also makes POLO-ECO plus significantly more advantageous in terms of ecology.

A study conducted by the Institute of Industrial Ecology confirms this. This study „Windsperger/ Steinlechner – Consideration of PP ML pipes from an ecological point of view“, was conducted in 1998, when the pipe system was introduced into the market, and showed that the polypropylene material and the mineral intermediate layer of POLO-ECO plus clearly reduce the environmental load.



GENERAL INFORMATION

MATERIAL CHARACTERISTICS

PRODUCT PERFORMANCE

OPERATIONAL PROPERTIES

RANGE OF PRODUCTS

LAYING INSTRUCTIONS

INVITATION TO TENDER TEXTS

Life cycle phases considered:

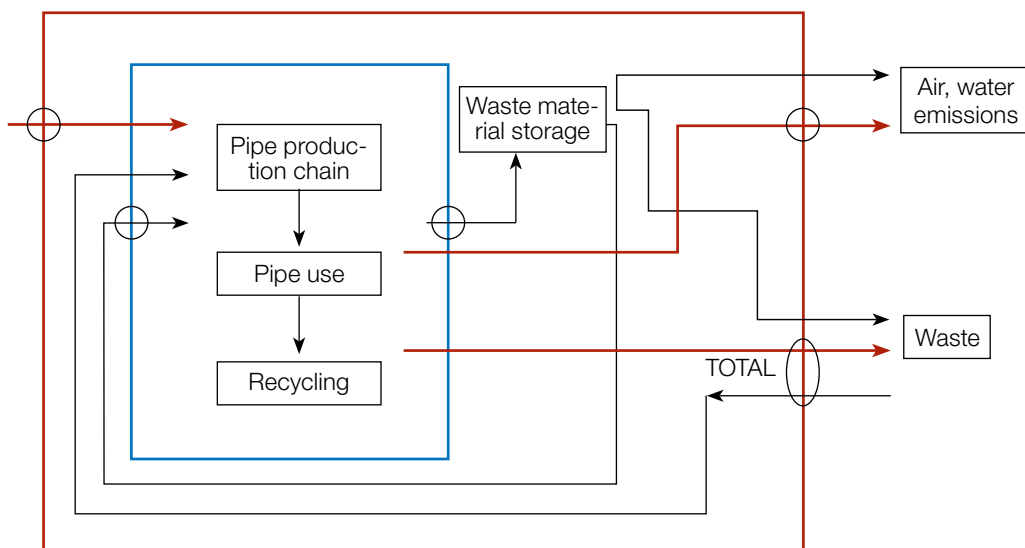

Summary of the 1998 study

The use of polypropylene as a pipe material and the mineral intermediary layer of POLO-ECO plus showed a significant reduction of the environmental load for the pipe diameters DN 160, DN 250 and DN 400. Compared to conventional one-layer polypropylene pipes, POLO-ECO plus shows that the quantity of fossil raw material and energy required, as well as the emissions into air and water, are reduced by approximately 30 to 40 per cent.

GENERAL INFORMATION

GENERAL INFORMATION

MATERIAL CHARACTERISTICS

PRODUCT PERFORMANCE

OPERATIONAL PROPERTIES

RANGE OF PRODUCTS

LAYING INSTRUCTIONS

INVITATION TO TENDER TEXTS

1.5 Standards and approvals

1.5.1 Standards

ON RULE-ONR 20513	Polypropylene plastic pipes systems with multi-layer wall structure (PP-ML) for unpressurized underground sewage pipes
ATV-DVWK-A 127	Structural analysis of waste water and sewage pipes
EN 1295-1	General requirements on the structural analyses of piping
ÖNORM B 2503	Additional instructions for design, construction and testing of sewage systems
EN 1610	Laying and testing of waste water and sewage piping
ENV 1046	Plastic pipe and protective pipe systems Systems beyond buildings, which convey water or waste water – Methods of above-ground and underground laying
EN 476	General requirements placed on structural components of waste water and sewage pipes

1.5.2 Approvals

Austria



Austria



Austria



Germany



Germany



Austria



Czechia



France



MATERIAL CHARACTERISTICS

2.1 Viscosity

Point loads and high differences of tension in the sewer pipe can arise, for example, as a consequence of coarse-grained soil or unsuitable bedding materials. POLO-ECO plus PREMIUM sewage pipes have been tested for such loads. This multi-layer polypropylene pipe features high protection against fractures and high viscosity.

Point load and impact penetration tests prove that the sewage pipes withstand high stress even if subject to extreme deformation. The tests also show that the material can relieve tensions that occur in the pipe wall under various loads.

Impact strength at low temperatures is proved using the falling-ball test with progressive loading according to EN 1411. POLO-ECO plus PREMIUM pipes even withstand severe test conditions such as material temperatures as low as $-20\text{ }^{\circ}\text{C}$.

2.1.1 Tests for resistance to point loads and toe-cracks



Puncture test using a pointed drift (ILLUSTRATION 1)

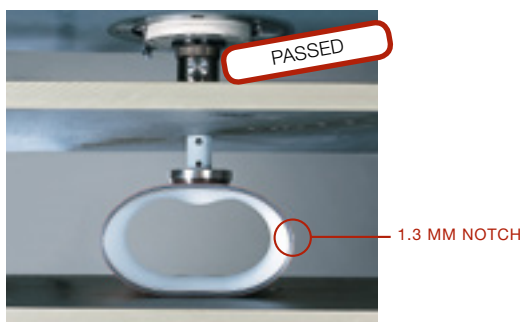

Point load test by making a notch at the side (ILLUSTRATION 2)

2.1.2 Tests for low-temperature impact strength

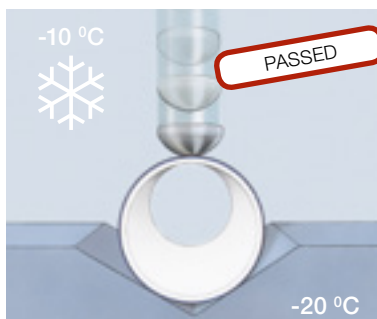

Low-temperature impact test, awarded the Ice Crystal Sign (ILLUSTRATION 3)

MATERIAL CHARACTERISTICS

GENERAL INFORMATION

MATERIAL CHARACTERISTICS

PRODUCT PERFORMANCE

OPERATIONAL PROPERTIES

RANGE OF PRODUCTS

LAYING INSTRUCTIONS

INVITATION TO TENDER TEXTS

2.2 Abrasion strength

Thanks to the favourable properties of the impact- and abrasion-resistant PP material, the POLO-ECO plus PREMIUM sewage pipe system offers a high degree of reliability and long lasting functionality.

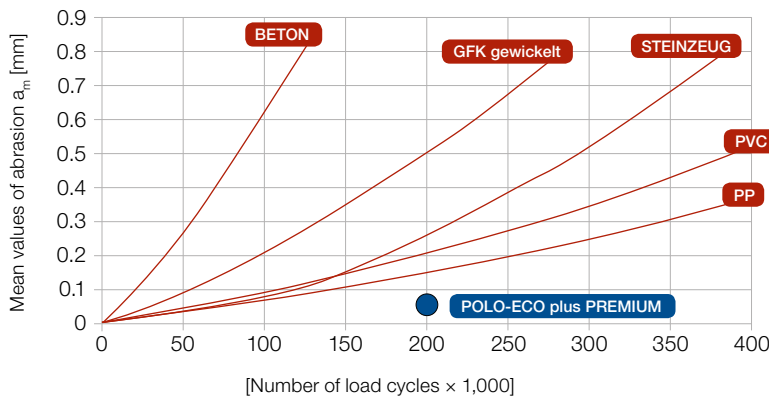

Abrasion of various pipe materials determined according to the Darmstadt method. Details: Brömstrup H., in PE systems in gas and water supply, published by Vulkan, 2006. with supplement POLO-ECO plus PREMIUM results of the abrasion test by OFI (Technologie & Innovation GmbH) – Test Report No. 306.359-5, Vienna, February 2008 (200.000 load cycles – abrasion 0.08 ± 0.01 [mm]) (ILLUSTRATION 4)

2.3 Chemical resistance

The Austrian Plastics Institution (OFI) has proved the resistance of the POLO-ECO plus PREMIUM pipe to a multitude of chemical substances. The resistance of the pipes is within the pH range from 2 to 13.

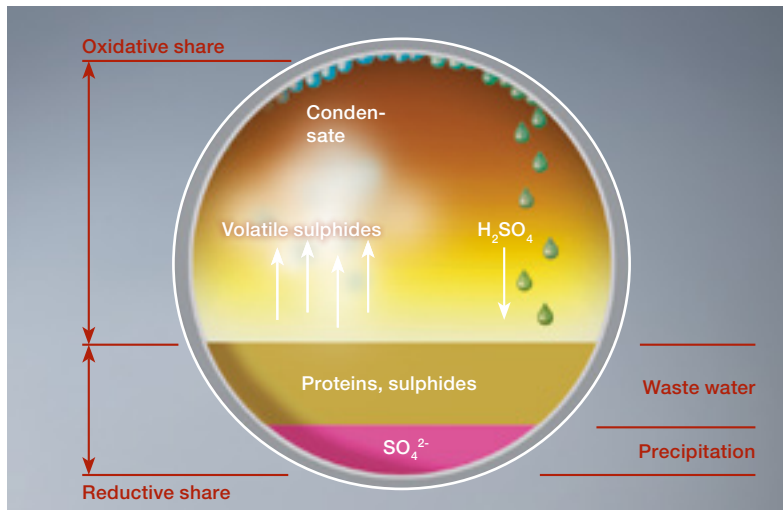

NOTE

If industrial waste water in high concentration is to be conveyed, the suitability of the entire system, including the seals, needs to be tested.

Formation of biological sulphuric acid in waste water pipes (ILLUSTRATION 5)

2.4 Resistance to de-icing salt

Particularly during the winter months, storm water pipes can be repeatedly subjected to massive chemical attacks by de-icing salt. The resistance of POLO-ECO plus PREMIUM and POLO-ECO plus PREMIUM RW to these chemical attacks is guaranteed.

PRODUCT PERFORMANCE

3.1 Wall thickness dimensioning

The three layers are extruded in one single working operation and fuse together during the cooling period. Dimensioning of the wall thickness is decisive for the operation, maintenance and longevity of the sewage pipe system.

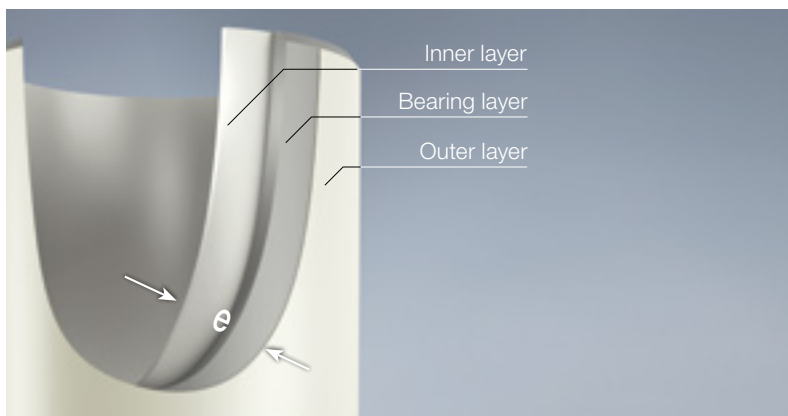

Wall thickness dimensioning (ILLUSTRATION 6)

POLO-ECO plus PREMIUM 10

SN 8	DN/OD	SDR*	s, min
	110	28	3.9
	125	29	4.3
	160	29	5.6
	200	29	6.9
	250	29	8.5
	315	29	10.8
	400	29	13.6
	500	29	17.1

POLO-ECO plus PREMIUM 12

SN 12	DN/OD	SDR*	s, min
	160	28	5.8
	200	28	7.2
	250	28	8.8
	315	28	11.2
	400	28	14.2
	500	28	17.8
	630	28	22.7

POLO-ECO plus PREMIUM 16

SN 16	DN/OD	SDR*	s, min
	160	27	5.9
	200	27	7.3
	250	27	9.1
	315	27	11.6
	400	27	14.6
	500	27	18.2
	630	28	22.8

POLO-ECO plus PREMIUM RW SN 16

SN 16	DN/OD	SDR*	s, min
	160	29	5.6
	200	29	6.9
	250	29	8.5
	315	29	10.8
	400	29	13.6
	500	29	17.1

SDR* = ratio between diameter and wall thickness Dimensions in mm
Standardized outer diameters ensure the compatibility with traditional plastic sewage pipes

Wall thickness dimensioning takes into consideration:

Outer layer:

- protective layer (outdoor exposure)
- protection against superficial damage
- increased longitudinal stability due to the specially developed PP-BLEND outer layer
- reduced degree of thermal absorption

PRODUCT PERFORMANCE

GENERAL INFORMATION

Bearing layer

- high rigidity
- high modulus of elasticity
- high stability in axial dimensions when laid on slight gradients
- high level of safety under extreme load
- withstands heavy loads
- high reliability with small overlap in height
- high reliability with large assembly depths

MATERIAL CHARACTERISTICS

Inner layer

- high abrasion resistance
- chemical Resistance
- resistance to impact and puncture during high-pressure cleaning
- extremely low abrasion

PRODUCT PERFORMANCE

3.2 Rigidity

3.2.1 Ring rigidity

With its ring rigidity class of SN 8, POLO-ECO plus PREMIUM 10 guarantees a very high degree of resistance to almost all assembly and operational loads. The SN 12 design offers a further plus of stability, and in POLO-ECO plus PREMIUM 16, the ring rigidity value was increased to SN 16 (!) while the wall thickness remained almost unchanged. This means a maximum of safety and a maximum of flow capacity.

OPERATIONAL PROPERTIES

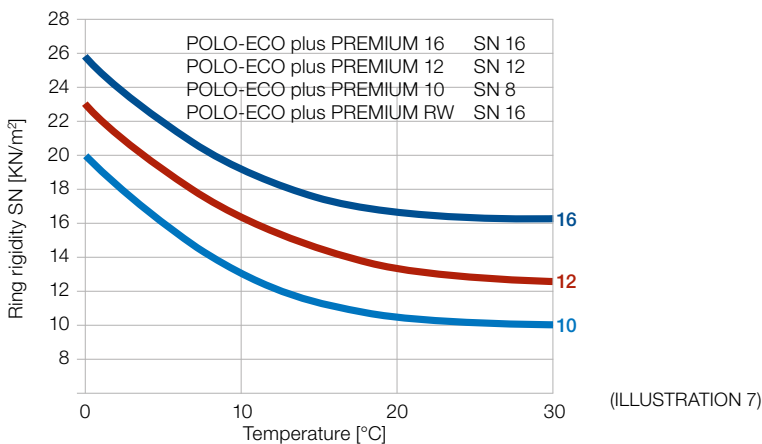

RANGE OF PRODUCTS

LAYING INSTRUCTIONS

INVITATION TO TENDER TEXTS

3.2.2 Longitudinal rigidity

If gravity sewer pipes are laid at low gradients, the longitudinal stability of the pipe needs to be reasonably high. The wall structure of POLO-ECO plus PREMIUM pipes ensures a perfect ratio between ring rigidity and excellent longitudinal stability.

PRODUCT PERFORMANCE

3.3 Longitudinal stability

3.3.1 Field test for proof of longitudinal stability, “bvfs” Salzburg, laying gradient 2 ‰

The “Salzburg Experiment and Research Institution in Structural Engineering” (bvfs) has investigated the fitness of POLO-ECO plus PREMIUM for practical use if laid at gradients around 2 ‰. The outcropping soil in the test area was classified as GS6 soil. Despite the very poor outcropping soil, POLO-ECO plus PREMIUM’s suitability for this case of use could be confirmed.

3.3.2 Longitudinal stability test by OFI – Austrian research institution in chemistry and technologies

If gravity sewer pipes are laid at low gradients, the longitudinal stability of the pipe needs to be reasonably high. The structure of POLO-ECO plus PREMIUM pipes ensures a perfect ratio between ring rigidity and excellent longitudinal stability. POLO-ECO plus PREMIUM 12 and POLO-ECO plus PREMIUM 10 fulfil these requirements in an optimal way. The specially developed, reinforced PP-BLEND outer layer reduces the degree of thermal absorption and thus makes a significant contribution to the product’s longitudinal stability.



(ILLUSTRATION 8)

Maximum curvature vs. temperature difference

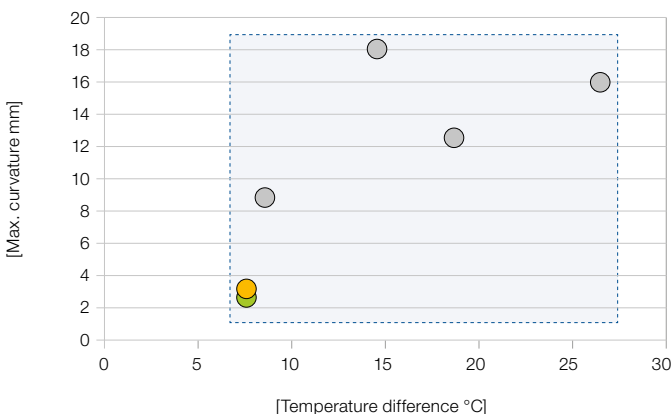

- POLO-ECO plus PREMIUM 10
- POLO-ECO plus PREMIUM 12
- other tested plastic pipe systems

Ask the manufacturers to provide the pipe test results concerning longitudinal stability!

Excerpt from the OFI test report No. 306.759-5 Vienna, January 2011

(ILLUSTRATION 9)

PRODUCT PERFORMANCE

GENERAL INFORMATION

MATERIAL CHARACTERISTICS

PRODUCT PERFORMANCE



Test setup, „ofi“ Laboratory (ILLUSTRATION 10)



„ofi“ test report (ILLUSTRATION 11)

OPERATIONAL PROPERTIES

RANGE OF PRODUCTS

LAYING INSTRUCTIONS

INVITATION TO TENDER TEXTS



„bvfs“ test assembly (ILLUSTRATION 12)



„bvfs“ measurement (ILLUSTRATION 13)

PRODUCT PERFORMANCE

3.4 Pipe rigidity and stability

Proof of stability of POLO-ECO plus sewage pipes

Before POLO-ECO plus PREMIUM was introduced into the market in 1997, the “Salzburg Experiment and Research Institution in Structural Engineering” (bvfs) was commissioned to examine the deformation behaviour of the POLO-ECO plus sewage pipes.

In a pilot test, two sewage pipes DN/OD 315, SN 8, were laid in differing laying quality in a gravel road that was subject to extremely high heavy-haul traffic.



Roadway:

Gravel road without the load-distributing effect of an asphalt or concrete pavement, maximum vehicle mass, including cargo: approx. 57 tons.

(ILLUSTRATION 14)

Assembly situation 1:

Optimal bedding and assembly conditions.

Assembly situation 1

Datum	Vertikal	Horizontal
15.11.97 (zero measurement)	292.9	288.6
26.05.98	285.9	294.4

Pipe diameter in mm

Assembly condition 2:

Low compaction, soft, resilient subsoil, poor assembly conditions.

Assembly situation 2

Datum	Vertikal	Horizontal
08.11.97 (zero measurement)	292.3	290.0
26.05.98	279.2	301.2

Pipe diameter in mm

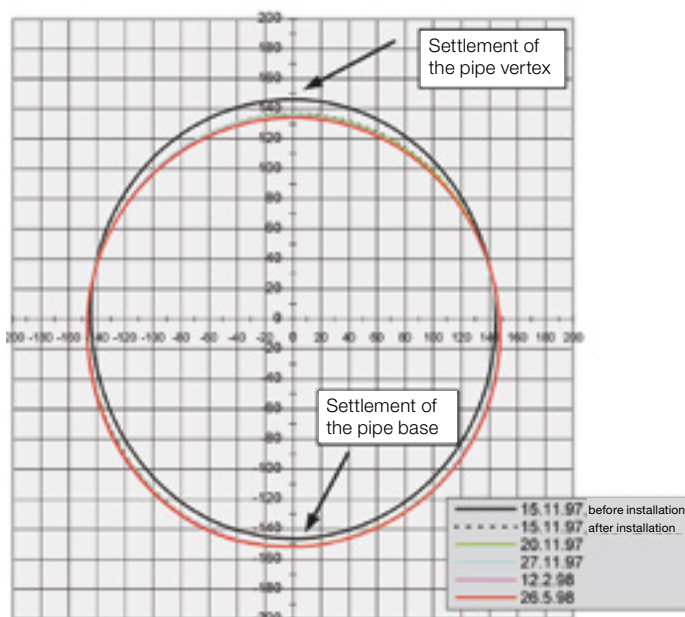

Change in shape of the pipe cross section/pipe settlement [mm]

(ILLUSTRATION 15)

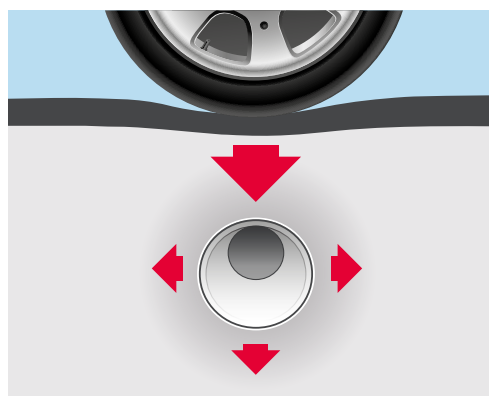

Pipe-soil interaction. The pipe changes its shape to relieve occurring tensions, which is why it then rests on the subsoil in a nearly tension-free condition. (ILLUSTRATION 16)

PRODUCT PERFORMANCE

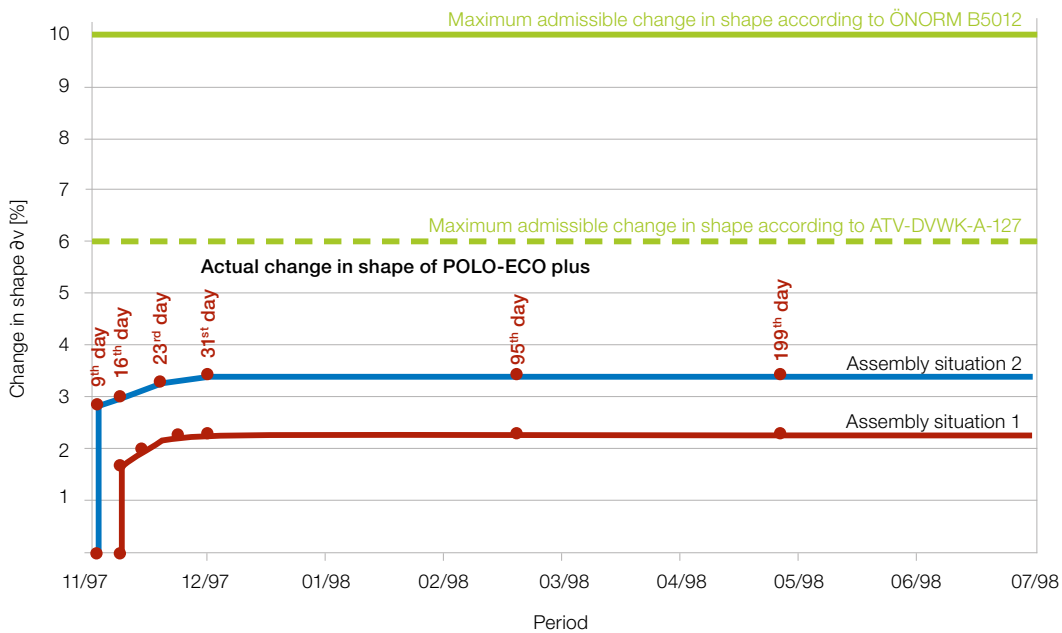

Actual change in shape of POLO-ECO plus over the measurement period (ILLUSTRATION 17)

Assembly situation 1: 2,3 % of change in shape of POLO-ECO plus during the pilot test

Assembly situation 2: 3,4 % of change in shape of POLO-ECO plus during the pilot test

The field test proves that POLO-ECO plus offers high margins of safety and is supremely suitable even for the most difficult assembly situations and extraordinarily high operation loads.

3.5 Long-time rupture strength

Thanks to the materials used, the layer adhesion of POLO-ECO plus PREMIUM pipes, as well as their long-time rupture strength, are excellent; apart from that, they also feature high resistance to abrasion and long-time impermeability.

The tests for long-time resistance to internal pressure were conducted by an accredited testing institution; as they constitute an essential quality criterion, they are continuously monitored.



Test of long-time rupture strength (ILLUSTRATION 18)

PRODUCT PERFORMANCE

3.6 Service life of more than 100 years

Thanks to the excellent material properties, the POLO-ECO plus PREMIUM sewage pipe system excels in its outstanding longevity.

Effectively tested and impressively proved.

3.6.1 Expert opinion

The following essential criteria were considered after long-time testing and examinations using state-of-the-art computer-assisted calculation methods:

- **Criteria in relation to the material:** thermooxidative ageing, mechanical fracturing properties examined in long-time rupture strength tests
- **Criteria in connection with the laying process:** Expert creation of the correct laying and bedding situation according to EN 1610, ÖNORM B 5012 and ATV-DVWK-A-127
- **The impressive result:** At a permanent working temperature of up to $T = 50\text{ °C}$, a service life of more than 100 years can be expected, **provided the pipes were laid expertly.**



OPERATIONAL PROPERTIES

4.1 Connection technique and leakproofness

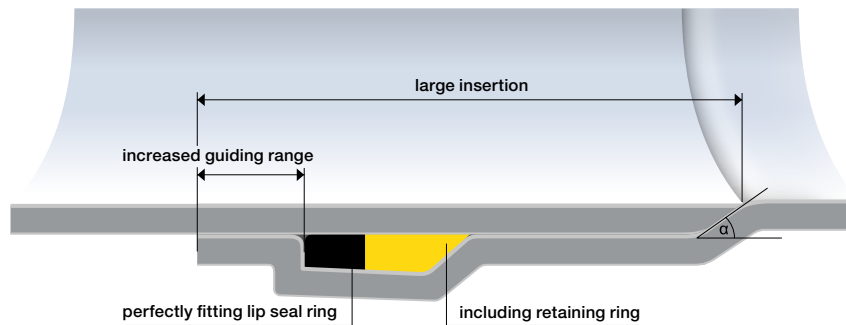

**POLO-TC
TOP
CONNECT**

POLO-TC (TOP-CONNECT)
Innovative socket system

- **Optimum positioning** of the sealing ring in the seam
- **Extraction-protected sealing ring** thanks to the factory-inserted PP-composite retaining ring
- **Moulded push-fit socket** the optimum angle α in the transition area between spigot end and socket base – **minimises the gap in the socket**
- **Increased guiding range** centres the pipe in an axial direction during insertion
- **Reliably leakproof** even with extreme change in shape
- **Large insertion depth** providing an additional margin of safety against extraction

4.2 High-pressure cleaning

Almost all of today's cleaning methods use spray nozzles and water jets under high pressure. The suitability of the pipe system for modern cleaning methods using high pressure has been proved in scavenging tests carried out by the OFI Technologie & Innovation GmbH.

High-pressure scavenging test

Scavenging pressure at the nozzle head	160 bar (± 5)
Jet angle of all nozzles	30°
Pipe diameter	DN/OD 200
Scavenging cycles	25 (50)
Subsequent test for leaks	0.3 and 0.5 bar
Quality Regulation	GRIS GV 15



High-pressure scavenging
(ILLUSTRATION 19)

OPERATIONAL PROPERTIES

4.3 High resistance to thermal stress

According to EN 476, Art. 6.5, the maximum temperature of waste water introduced into the pipe system is 45 °C. In this context, the polypropylene material used offers outstanding safety margins (see Illustration 20).

Thermal resistance

- assembly temperature: -20 °C to +50 °C
- working temperature: Resistance to changes in temperature from 10 °C to 95 °C

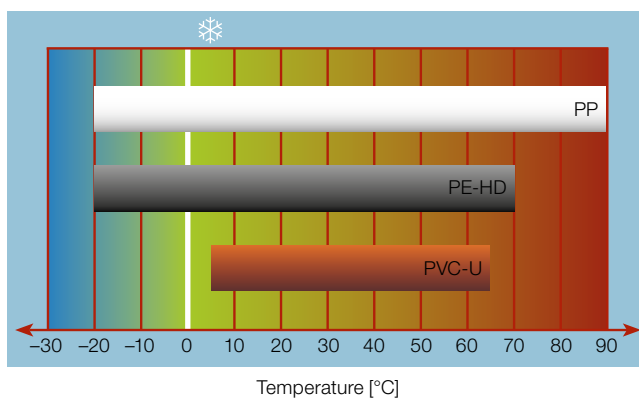

Working temperature range (ILLUSTRATION 20)

GENERAL INFORMATION

MATERIAL CHARACTERISTICS

PRODUCT PERFORMANCE

OPERATIONAL PROPERTIES

RANGE OF PRODUCTS

LAYING INSTRUCTIONS

INVITATION TO TENDER TEXTS

RANGE OF PRODUCTS

5.1 POLO-ECO plus PREMIUM 16

5.1.1 Technical data

GENERAL INFORMATION	Designation	POLO-ECO plus PREMIUM 16
	Pipe	PP sewage pipe with three-layered solid wall structure
MATERIAL CHARACTERISTICS	Fittings	Up to DN/OD 200, mostly injection-moulded, from DN/OD 250 with three-layered walls, hand-moulded, connections welded using heat reflector welding or extrusion welding
	Pipe material	Polypropylene (PP-BLEND)/PP-MV/PP without halogen or lead
	Colour	Outer layer – opal white similar to RAL Design 1209005 Bearing layer – titan grey similar to RAL 9011 Inner layer – light grey similar to RAL 7035
PRODUCT PERFORMANCE	Ring rigidity	POLO-ECO plus PREMIUM 16 ($\geq 16 \text{ kN/m}^2$) at 23 °C according to EN ISO 9969
	Dimensions Outer diameter	Nominal diameters DN/OD 160, 200, 250, 315, 400, 500 and 630 mm
	Installation lengths	Pipes with push-fit sockets 1 m, 3 m and 6 m Pipes without push-fit socket (for a hinged connection to the duct) 1 m
OPERATIONAL PROPERTIES	Pipe connection	Moulded POLO-TC (TOP-CONNECT) socket system with PP supporting ring and/or weld-on injection-moulded socket, DN/OD 630 without PP supporting ring, with highly elastic, non-ageing lip ring seal, BL system, made of elastomers according to DIN 4060
	Seal	Highly elastic, non-ageing lip ring seal BL (SBR) system made of elastomer according to EN 681-1, NBR lip ring seals for increased demands concerning resistance to oil and grease, and EPDM-TW lip ring seals in applications that require suitability for drinking water
RANGE OF PRODUCTS	Mean coefficient of elongation	0.04 mm/m ^{°K}
	Chemical resistance	Pipes and fittings made of PP – according to DIN 8078, supplement 1 seals made of SBR/NBR – according to ISO TR 7620
	Temperature range of use	-20 to +95 °C
LAYING INSTRUCTIONS	Pipe roughness	k = 0.01 mm
	Hot-water resistance	short-time: 97 °C 30 sec./day = 152 hrs./50 years long-time 95 °C 10 min./day = 3,000 hrs./50 years long-time 60 °C 5 hrs./day = 87,600 hrs./50 years

RANGE OF PRODUCTS

Pipe marking

POLO-ECO plus PREMIUM sewage pipes bear the following marking: Designation, class of rigidity, company name in short, outer diameter × wall thickness, material, low-temperature range of use, range of melt flow indices, application area code, approval body/test number, test label/ test number and date of manufacture.

Standard physical values

Designation	Unit	Value	Standard
Melt index range (230 °C/2.16 kg)	g/10 min.	0.3–0.6	ISO 1133
Average density	g/cm ³	1.20	ISO 1183
Yield stress	N/mm ²	> 24	ISO 527-2
E-modulus, short-time	MPa	> 3,400	
E-modulus, long-time	MPa	> 900	

5.1.2 Nominal diameters – dimensions – masses

5.1.2.1 POLO-ECO plus PREMIUM 16 sewage pipe product line

Dimensions in mm

POLO-ECO plus PREMIUM 16
Push-fit socket pipe
with factory-fitted lip ring



A. no.	DN/OD**	L	s1 (min)	t	D	kg/pc.*
07221	160	1000	5.9	96.0	187	4.3
07223	160	3000	5.9	96.0	187	11.9
07226	160	6000	5.9	96.0	187	23.3
07231	200	1000	7.3	119.0	232	6.9
07233	200	3000	7.3	119.0	232	18.8
07236	200	6000	7.3	119.0	232	36.7
07241	250	1000	9.1	152.0	290	11.3
07243	250	3000	9.1	152.0	290	29.8
07246	250	6000	9.1	152.0	290	57.6
07251	315	1000	11.6	184.0	363	18.3
07253	315	3000	11.6	184.0	363	47.9
07256	315	6000	11.6	184.0	363	92.2
07261	400	1000	14.6	237.0	458	30.7
07263	400	3000	14.6	237.0	458	78.0
07266	400	6000	14.6	237.0	458	148.9
07271	500	1000	18.2	288.0	572	49.2
07273	500	3000	18.2	288.0	572	123.2
07276	500	6000	18.2	288.0	572	234.1
07281	630	1000	22,8	293,0	710	80.3
07283	630	3000	22,8	293,0	710	197.6
07286	630	6000	22,8	293,0	710	373.7

* approximate weights

** DN/OD – according to EN 476 Dimension Nominal/Outside Diameter

Subject to technical alterations

RANGE OF PRODUCTS

Dimensions in mm

GENERAL INFORMATION

POLO-ECO plus PREMIUM 16
Pipe without push-fit socket
 for a hinged connection to the duct



A. no.	DN/OD**	L	s1 (min)	kg/pc.*
07182	160	1000	5.9	3.8
07183	200	1000	7.3	6.0
07184	250	1000	9.1	9.3
07185	315	1000	11.6	14.8
07186	400	1000	14.6	23.7
07187	500	1000	18.2	37.0
07188	630	1000	22.8	58.7

MATERIAL CHARACTERISTICS

PRODUCT PERFORMANCE

OPERATIONAL PROPERTIES

RANGE OF PRODUCTS

LAYING INSTRUCTIONS

INVITATION TO TENDER TEXTS

* approximate weights

** DN/OD – according to EN 476 Dimension Nominal/Outside Diameter

Subject to technical alterations

RANGE OF PRODUCTS

5.2 POLO-ECO plus PREMIUM 12

5.2.1 Technical data

Designation	POLO-ECO plus PREMIUM 12	
Pipe	PP sewage pipe with three-layered solid wall structure	
Fittings	Up to DN/OD 200, mostly injection-moulded, from DN/OD 250 with three-layered walls, hand-moulded, connections welded using heat reflector welding or extrusion welding	
Pipe material	Polypropylen (PP-BLEND)/PP-MV/PP-MV	
Colour	Outer layer – opal white	similar to RAL Design 1209005
	Bearing layer – titan grey	similar to RAL 9011
	Inner layer – light grey	similar to RAL 7035
Ring rigidity	POLO-ECO plus PREMIUM 12 (≥ 12 kN/m ²) at 23 °C according to EN ISO 9969	
Dimensions	Nominal diameters DN/OD 160, 200, 250, 315, 400, 500 and 630 mm	
Outer diameter		
Installation lengths	Pipes with push-fit sockets 1 m, 3 m and 6 m Pipes without push-fit socket (for a hinged connection to the duct) 1 m	
Pipe connection	Moulded POLO-TC (TOP-CONNECT) socket system with PP supporting ring and/or weld-on injection-moulded socket, DN/OD 630 without PP supporting ring and highly elastic, non-aging lip ring seal, BL system, made of elastomers according to DIN 4060	
Seal	Highly elastic, non-ageing lip ring seal BL (SBR) system made of elastomer according to EN 681-1, NBR lip ring seals for increased demands concerning resistance to oil and grease, and EPDM-TW lip ring seals in applications that require suitability for drinking water	
Mean coefficient of elongation	0.04 mm/m°K	
Chemical resistance	Pipes and fittings made of PP – according to DIN 8078, supplement 1 seals made of SBR/NBR – according to ISO TR 7620	
Temperature range of use	-20 to +95 °C	
Pipe roughness	k = 0.01 mm	
Hot-water resistance	short-time 97 °C	30 sec./day = 152 hrs./50 years
	long-time 95 °C	10 min./day = 3,000 hrs./50 years
	long-time 60 °C	5 hrs./day = 87,600 hrs./50 years

GENERAL INFORMATION

MATERIAL CHARACTERISTICS

PRODUCT PERFORMANCE

OPERATIONAL PROPERTIES

RANGE OF PRODUCTS

LAYING INSTRUCTIONS

INVITATION TO TENDER TEXTS

RANGE OF PRODUCTS

GENERAL INFORMATION

Pipe marking

POLO-ECO plus PREMIUM sewage pipes bear the following marking: Designation, class of rigidity, company name in short, outer diameter × wall thickness, material, low-temperature range of use, range of melt flow indices, application area code, approval body/test number, test label/test number and date of manufacture.

MATERIAL CHARACTERISTICS

Standard physical values

Designation	Unit	Value	Standard
Melt index range (230 °C/2.16 kg)	g/10 min.	0.3–0.6	ISO 1133
Average density	g/cm ³	1.20	ISO 1183
Yield stress	N/mm ²	> 24	ISO 527-2
E-modulus, short-time	MPa	> 3,200	
E-modulus, long-time	MPa	> 850	

5.2.2 Nominal diameters – dimensions – masses

5.2.2.1 POLO-ECO plus PREMIUM 12 sewage pipe product line

Dimensions in mm

PRODUCT PERFORMANCE

POLO-ECO plus PREMIUM 12
Push-fit socket pipe
with factory-fitted lip ring



A. no.	DN/OD**	L	s1 (min)	t	D	kg/pc.*
06221	160	1000	5.8	96.0	187	4.3
06223	160	3000	5.8	96.0	187	11.8
06226	160	6000	5.8	96.0	187	23.1
06231	200	1000	7.2	119.0	232	6.6
06233	200	3000	7.2	119.0	232	18.2
06236	200	6000	7.2	119.0	232	35.5
06241	250	1000	8.8	152.0	290	11.0
06243	250	3000	8.8	152.0	290	28.8
06246	250	6000	8.8	152.0	290	56.2
06251	315	1000	11.2	184.0	363	17.8
06253	315	3000	11.2	184.0	363	46.2
06256	315	6000	11.2	184.0	363	89.0
06261	400	1000	14.2	237.0	458	29.2
06263	400	3000	14.2	237.0	458	74.6
06266	400	6000	14.2	237.0	458	143.0
06271	500	1000	17.8	288.0	572	47.9
06273	500	3000	17.8	288.0	572	119.7
06276	500	6000	17.8	288.0	572	226.5
06281	630	1000	22.7	293.0	710	73.9
06283	630	3000	22.7	293.0	710	187.2
06286	630	6000	22.7	293.0	710	356.9

OPERATIONAL PROPERTIES

RANGE OF PRODUCTS

LAYING INSTRUCTIONS

INVITATION TO TENDER TEXTS

* approximate weights

** DN/OD – according to EN 476 Dimension Nominal/Outside Diameter

Subject to technical alterations

RANGE OF PRODUCTS

Dimensions in mm

POLO-ECO plus PREMIUM 12
Pipe without push-fit socket
 for a hinged connection to the duct



A. no.	DN/OD**	L	s1 (min)	kg/pc.*
06182	160	1000	5.8	3.7
06183	200	1000	7.2	5.8
06184	250	1000	8.8	8.9
06185	315	1000	11.2	14.8
06186	400	1000	14.2	22.5
06187	500	1000	17.8	36.1
06188	630	1000	22.7	56.6

GENERAL INFORMATION

MATERIAL CHARACTERISTICS

PRODUCT PERFORMANCE

OPERATIONAL PROPERTIES

RANGE OF PRODUCTS

LAYING INSTRUCTIONS

INVITATION TO TENDER TEXTS

* approximate weights

** DN/OD – according to EN 476 Dimension Nominal/Outside Diameter

Subject to technical alterations

RANGE OF PRODUCTS

5.3 POLO-ECO plus PREMIUM 10

5.3.1 Technical data

GENERAL INFORMATION	Designation	POLO-ECO plus PREMIUM 10
	Pipe	PP sewage pipe with three-layered solid wall structure
MATERIAL CHARACTERISTICS	Fittings	Up to DN/OD 200, mostly injection-moulded, from DN/OD 250 with three-layered walls, hand-moulded, connections welded using heat reflector welding or extrusion welding
	Pipe material	Polypropylene (PP-BLEND)/PP-MV/PP without halogen or lead
	Colour	Outer layer – opal white similar to RAL Design 1209005 Bearing layer – titan grey similar to RAL 9011 Inner layer – light grey similar to RAL 7035
PRODUCT PERFORMANCE	Ring rigidity	POLO-ECO plus PREMIUM 10 (≥ 10 kN/m ²) at 23 °C according to EN ISO 9969
	Dimensions Outer diameter	DN/OD 110, 125, 160, 200, 250, 315, 400 and 500 mm
	Installation lengths	Pipes with push-fit sockets 1 m, 3 m and 6 m Pipes without push-fit socket (for a hinged connection to the duct) 1 m
OPERATIONAL PROPERTIES	Pipe connection	Moulded POLO-TC (TOP-CONNECT) socket system with PP supporting ring highly elastic, non-ageing lip ring seal, BL system, made of elastomers according to DIN 4060
	Seal	Highly elastic, non-ageing lip ring seal BL (SBR) system made of elastomer according to EN 681-1, NBR lip ring seals for increased demands concerning resistance to oil and grease, and EPDM-TW lip ring seals in applications that require suitability for drinking water
RANGE OF PRODUCTS	Mean coefficient of elongation	0.04 mm/m ^{°K}
	Chemical resistance	Pipes and fittings made of PP – according to DIN 8078, supplement 1 seals made of SBR/NBR – according to ISO TR 7620
	Temperature range of use	-20 to +95 °C
LAYING INSTRUCTIONS	Pipe roughness	k = 0.01 mm
	Hot-water resistance	short-time 97 °C 30 sec./day = 152 hrs./50 years long-time 95 °C 10 min./day = 3,000 hrs./50 years long-time 60 °C 5 hrs./day = 87,600 hrs./50 years

RANGE OF PRODUCTS

Pipe marking

POLO-ECO plus PREMIUM sewage pipes bear the following marking: Designation, class of rigidity, company name in short, outer diameter × wall thickness, material, low-temperature range of use, range of melt flow indices, application area code, approval body/test number, test label/ test number and date of manufacture.

Standard physical values

Designation	Unit	Value	Standard
Melt index range (230 °C/2.16 kg)	g/10 min.	0.3–0.6	ISO 1133
Average density	g/cm ³	1.20	ISO 1183
Yield stress	N/mm ²	> 24	ISO 527-2
E-modulus, short-time	MPa	> 3,200	
E-modulus, long-time	MPa	> 850	

5.3.2 Nominal diameters – dimensions – masses

5.3.2.1 POLO-ECO plus PREMIUM 10 sewage pipe product line

Dimensions in mm

POLO-ECO plus PREMIUM 10
Push-fit socket pipe
 with factory-fitted lip ring



A. no.	DN/OD**	L	s1 (min)	t	D	kg/pc.*
05201	110	1000	3.9	81.0	130	1.9
05203	110	3000	3.9	81.0	130	5.3
05206	110	6000	3.9	81.0	130	10.5
05211	125	1000	4.3	87.0	148	2.5
05213	125	3000	4.3	87.0	148	6.9
05216	125	6000	4.3	87.0	148	13.6
05221	160	1000	5.6	96.0	187	4.0
05223	160	3000	5.6	96.0	187	11.2
05226	160	6000	5.6	96.0	187	22.0
05231	200	1000	6.9	119.0	231	6.2
05233	200	3000	6.9	119.0	231	17.2
05236	200	6000	6.9	119.0	231	33.6
05241	250	1000	8.5	152.0	293	10.2
05243	250	3000	8.5	152.0	293	27.3
05246	250	6000	8.5	152.0	293	53.3
05251	315	1000	10.8	184.0	363	16.8
05253	315	3000	10.8	184.0	363	43.6
05256	315	6000	10.8	184.0	363	84.8
05261	400	1000	13.6	237.0	457	28.2
05263	400	3000	13.6	237.0	457	70.6
05266	400	6000	13.6	237.0	457	136.2
05271	500	1000	17.1	288.0	571	45.8
05273	500	3000	17.1	288.0	571	113.8
05276	500	6000	17.1	288.0	571	214.8

* approximate weights

** DN/OD – according to EN 476 Dimension Nominal/Outside Diameter

Subject to technical alterations

RANGE OF PRODUCTS

Dimensions in mm

GENERAL INFORMATION

POLO-ECO plus PREMIUM 10
Pipe without push-fit socket
 for a hinged connection to the duct



MATERIAL CHARACTERISTICS

A. no.	DN/OD**	L	s1 (min)	kg/pc.*
05180	110	1000	3.9	1.7
05181	125	1000	4.3	2.2
05182	160	1000	5.6	3.5
05183	200	1000	6.9	5.4
05184	250	1000	8.5	8.4
05185	315	1000	10.8	14.1
05186	400	1000	13.6	21.2
05187	500	1000	17.1	33.2

PRODUCT PERFORMANCE

OPERATIONAL PROPERTIES

RANGE OF PRODUCTS

LAYING INSTRUCTIONS

INVITATION TO TENDER TEXTS

* approximate weights

** DN/OD – according to EN 476 Dimension Nominal/Outside Diameter

Subject to technical alterations

RANGE OF PRODUCTS

5.4 POLO-ECO plus PREMIUM RW

5.4.1 Technical data

Designation	POLO-ECO plus PREMIUM RW	
Area of Application	Storm water drainage in separated systems	
Pipe	PP sewage pipe with three-layered solid wall structure	
Fittings	Up to DN/OD 200, mostly injection-moulded, from DN/OD 250 with three-layered walls, hand-moulded, connections welded using heat reflector welding or extrusion welding, in opal white colour without blue stripes	
Pipe material	Polypropylene (PP-BLEND)/PP-MV/PP without halogen or lead	
Colour	Outer layer – opal white (similar to RAL Design 1209005) with blue stripes (RAL 5019) at the third points Bearing layer – titan grey similar to RAL 9011 Inner layer – light grey similar to RAL 7035	
Ring rigidity	POLO-ECO plus PREMIUM RW SN 16 (actual ring rigidity > 16 kN/m ²) at 23 °C according to EN ISO 9969	
Dimensions Outer diameter	Nominal diameters DN/OD 160, 200, 250, 315, 400 and 500 mm	
Installation lengths	Pipes with push-fit sockets 1 m, 3 m and 6 m Pipes without push-fit socket (for a hinged connection to the duct) 1 m	
Pipe connection	Moulded POLO-TC (TOP-CONNECT) socket system with PP supporting ring highly elastic, non-ageing lip ring seal, BL system, made of elastomers according to DIN 4060	
Seal	Highly elastic, non-ageing lip ring seal BL (SBR) system made of elastomer according to EN 681-1, NBR lip ring seals for increased demands concerning resistance to oil and grease, and EPDM-TW lip ring seals in applications that require suitability for drinking water	
Pipe marking	POLO-ECO plus PREMIUM RW sewage pipes bear the following marking: Designation, class of rigidity, company name in short, outer diameter × wall thickness, material, low-temperature range of use, range of melt flow indices, application area code, approval body/test number, test label/test number and date of manufacture.	
Chemical resistance	Pipes and fittings made of PP – according to DIN 8078, supplement 1 seals made of SBR according to ISO TR 7620	
Temperature range of use	-20 to +95 °C	

GENERAL INFORMATION

MATERIAL
CHARACTERISTICS

PRODUCT
PERFORMANCE

OPERATIONAL
PROPERTIES

RANGE OF PRODUCTS

LAYING INSTRUCTIONS

INVITATION TO TENDER
TEXTS

RANGE OF PRODUCTS

GENERAL INFORMATION

Pipe roughness $k = 0.01 \text{ mm}$

Mean coefficient of linear expansion $0.04 \text{ mm/m}^\circ\text{K}$

MATERIAL CHARACTERISTICS

Standard physical values

Designation	Unit	Value	Standard
Melt index range (230 °C/2.16 kg)	g/10 min.	0.3–0.6	ISO 1133
Average density	g/cm ³	1.18	ISO 1183
Yield stress	N/mm ²	> 24	ISO 527-2
E-modulus, short-time	MPa	> 3,200	
E-modulus, long-time	MPa	> 850	

5.4.2 Nominal diameters – dimensions – masses

5.4.2.1 POLO-ECO plus PREMIUM RW SN 16 pipe product line

Dimensions in mm

PRODUCT PERFORMANCE

POLO-ECO plus PREMIUM RW
Push-fit socket pipe
 with factory-fitted lip ring



A. no.	DN/OD**	L	s1 (min)	t	D	kg/pc.*
05011	160	1000	5.6	96.0	187.0	4.0
05013	160	3000	5.6	96.0	187.0	11.2
05014	160	6000	5.6	96.0	187.0	22.0
05016	200	1000	6.9	119.0	231.0	6.2
05018	200	3000	6.9	119.0	231.0	17.2
05019	200	6000	6.9	119.0	231.0	33.6
05020	250	1000	8.5	152.0	293.0	10.2
05022	250	3000	8.5	152.0	293.0	27.3
05023	250	6000	8.5	152.0	293.0	53.3
05024	315	1000	10.8	184.0	363.0	16.8
05026	315	3000	10.8	184.0	363.0	43.6
05027	315	6000	10.8	184.0	363.0	84.8
05028	400	1000	13.6	237.0	457.0	28.2
05030	400	3000	13.6	237.0	457.0	70.6
05031	400	6000	13.6	237.0	457.0	136.2
05032	500	1000	17.1	288.0	571.0	45.8
05033	500	3000	17.1	288.0	571.0	113.8
05034	500	6000	17.1	288.0	571.0	214.8

OPERATIONAL PROPERTIES

RANGE OF PRODUCTS

LAYING INSTRUCTIONS

INVITATION TO TENDER TEXTS

* approximate weights

** DN/OD – according to EN 476 Dimension Nominal/Outside Diameter

Subject to technical alterations

RANGE OF PRODUCTS

Dimensions in mm

POLO-ECO plus PREMIUM RW
Pipe without push-fit socket
 for a hinged connection to the duct



A. no.	DN/OD**	L	s1 (min)	kg/pc.*
05042	160	1000	5.6	3.5
05043	200	1000	6.9	5.4
05044	250	1000	8.5	8.4
05045	315	1000	10.8	14.1
05046	400	1000	13.6	21.2
05047	500	1000	17.1	33.2

GENERAL INFORMATION

MATERIAL CHARACTERISTICS

PRODUCT PERFORMANCE

OPERATIONAL PROPERTIES

RANGE OF PRODUCTS

LAYING INSTRUCTIONS

INVITATION TO TENDER TEXTS

* approximate weights

** DN/OD – according to EN 476 Dimension Nominal/Outside Diameter

Subject to technical alterations

RANGE OF PRODUCTS

GENERAL INFORMATION

MATERIAL CHARACTERISTICS

PRODUCT PERFORMANCE

OPERATIONAL PROPERTIES

RANGE OF PRODUCTS

LAYING INSTRUCTIONS

INVITATION TO TENDER TEXTS

Hinged connection to the duct

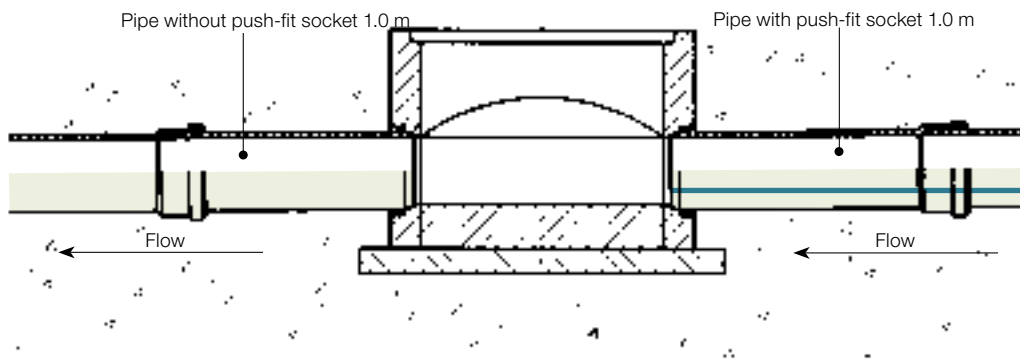

Note

When ordering the **lower part of the duct**, please indicate that the connecting sleeve must be moulded to fit a POLO-ECO plus PREMIUM 16, POLO-ECO plus PREMIUM 12, POLO-ECO plus PREMIUM 10, or a POLO-ECO plus PREMIUM RW SN 16 pipe. The indication of this data is the only way **to avoid mismatches in height** in the transition area between pipe and duct base.

5.5 POLO-ECO plus PREMIUM . POLO-ECO plus PREMIUM RW Fittings

Fittings for POLO-ECO plus PREMIUM 16 . 12 . 10 and POLO-ECO plus PREMIUM RW SN 16

Because of their geometrical shape, the rigidity value of fittings is **usually at least twice** the rigidity of the pipe. This is why fittings of a certain nominal ring rigidity can be used in combination with pipes of up to twice their class of rigidity.

Dimensions in mm

POLO-ECO plus PREMIUM Bend		A. no.	DN/OD**	Z1	Z2	L	design	kg/pc.*
$\alpha=7.5^\circ$ made of polypropylene, with inserted lip seal ring Heat reflector weld connection all bends "without" internal bead		06320	160	43.0	71.0	139.0	HF	1.3
		06330	200	34.5	136.0	153.0	HF	1.9
		06340	250	33.5	84.0	186.0	HF	4.2
		06350	315	49.0	160.5	233.0	HF	6.0
		06360	400	57.5	165.5	293.0	HF	16.3
		06370	500	65.0	193.5	350.0	HF	31.0
		06380	630	57.0	466.5	350.5	HF	38.0
$\alpha=15^\circ$		06301	110	13.0	13.0	80.0	SG	0.3
		06311	125	11.5	13.5	85.5	SG	0.4
		06321	160	13.0	16.0	98.0	SG	0.7
		06331	200	13.0	23.0	131.0	SG	1.4
		06341	250	31.5	95.0	183.5	HF	3.2
		06351	315	59.0	124.5	243.0	HF	8.7
		06361	400	68.5	159.0	304.0	HF	16.9
		06371	500	79.0	184.0	364.0	HF	31.2
		06381	630	78.5	487.5	371.5	HF	38.0

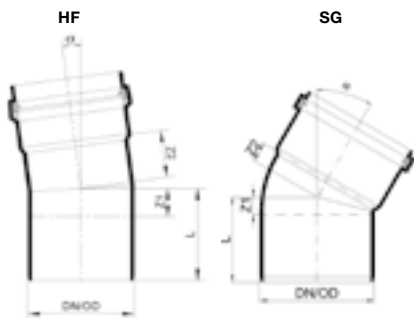

SG ... injection moulding

HF ... hand moulding



* approximate weights

** DN/OD – according to EN 476 Dimension Nominal/Outside Diameter

Subject to technical alterations

RANGE OF PRODUCTS

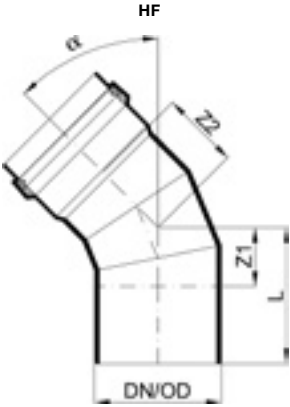
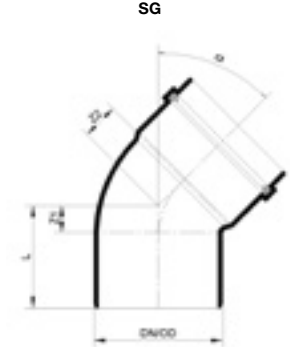
Dimensions in mm

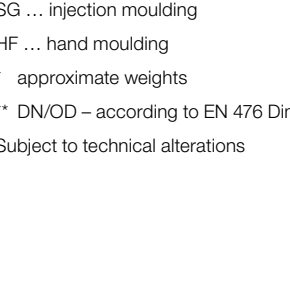
POLO-ECO plus PREMIUM Bend		A. no.	DN/OD**	Z1	Z2	L	design	kg/pc.*
$\alpha=30^\circ$	<p>made of polypropylene, with inserted lip seal ring Heat reflector weld connection</p> <p>all bends "without" internal bead</p> 	06302	110	21.0	20.5	88.0	SG	0.3
		06312	125	19.5	21.5	93.5	SG	0.4
		06322	160	25.0	28.0	110.0	SG	0.8
		06332	200	27.0	37.0	144.0	SG	1.7
		06342	250	61.5	111.0	213.5	HF	4.6
		06352	315	84.0	141.0	268.0	HF	8.8
		06362	400	96.0	195.0	331.0	HF	17.0
		06372	500	108.0	212.5	393.0	HF	33.7
		06382	630	121.5	370.0	414.5	HF	63.5
$\alpha=45^\circ$		06303	110	29.0	29.0	96.0	SG	0.3
		06313	125	29.0	31.0	103.0	SG	0.5
		06323	160	37.0	41.0	122.5	SG	0.9
		06333	200	41.0	52.0	159.0	SG	2.0
		06343	250	117.0	154.5	269.0	HF	5.6
		06353	315	151.0	225.0	335.0	HF	10.9
		06363	400	192.5	297.0	429.5	HF	21.5
		06373	500	242.0	321.0	530.0	HF	39.6
		06383	630	313.5	592.5	606.5	HF	87.0
$\alpha=67.5^\circ$		06304	110	44.0	44.0	111.0	SG	0.3
		06314	125	46.0	48.0	120.0	SG	0.5
		06324	160	59.0	62.0	144.0	SG	0.9
		06334	200	133.0	198.0	252.0	HF	3.4
$\alpha=87.5^\circ$		06305	110	60.5	60.0	127.5	SG	0.3
		06315	125	64.0	66.5	138.5	SG	0.5
		06325	160	84.0	87.0	169.0	SG	1.0
		06335	200	106.0	115.0	230.0	SG	2.4
		06345	250	223.0	281.0	375.0	HF	6.8
		06355	315	313.0	373.0	497.0	HF	14.1
		06365	400	430.0	520.0	665.0	HF	24.4
		06375	500	495.0	586.0	780.0	HF	52.3
		06385	630	607.0	855.5	900.0	HF	103.5

SG ... injection moulding

HF ... hand moulding

* approximate weights

** DN/OD – according to EN 476 Dimension Nominal/Outside Diameter

Subject to technical alterations

GENERAL INFORMATION

MATERIAL CHARACTERISTICS

PRODUCT PERFORMANCE

OPERATIONAL PROPERTIES

RANGE OF PRODUCTS

LAYING INSTRUCTIONS

INVITATION TO TENDER TEXTS

RANGE OF PRODUCTS

Dimensions in mm

GENERAL INFORMATION

POLO-ECO plus PREMIUM Branch

made of polypropylene,
with inserted lip seal ring,
extrusion weld connection

$\alpha=45^\circ$

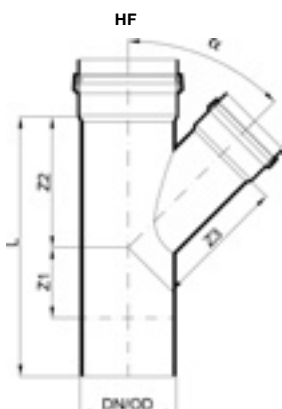

MATERIAL CHARACTERISTICS

PRODUCT PERFORMANCE

OPERATIONAL PROPERTIES

RANGE OF PRODUCTS

LAYING INSTRUCTIONS

INVITATION TO TENDER TEXTS

A. no.	DN/OD**	Z1	Z2	Z3	L	design	kg/pc.*
06400	110/110	29.0	144.0	144.0	240.0	SG	0.7
06401	125/110	28.0	160.5	154.0	262.5	SG	0.9
06402	125/125	28.0	160.5	160.5	262.5	SG	1.0
06403	160/110	25.0	174.0	184.0	261.0	SG	1.3
06405	160/160	35.0	209.0	209.0	329.0	SG	1.9
06408	200/160	13.0	234.0	256.0	365.0	SG	3.4
06409	200/200	52.0	240.0	239.5	416.0	SG	4.0
06412	250/160	193.5	331.0	327.5	680.0	HF	6.9
06413	250/200	185.0	343.5	359.0	680.0	HF	8.2
06414	250/250	138.0	386.5	383.0	680.0	HF	10.2
06417	315/160	136.0	361.0	373.0	680.0	HF	11.1
06418	315/200	108.0	390.0	407.0	680.0	HF	14.5
06419	315/250	72.5	429.0	433.0	680.0	HF	15.5
06420	315/315	361.0	455.0	456.0	1000.0	HF	24.4
06423	400/160	271.5	495.0	534.0	1000.0	HF	28.9
06424	400/200	327.0	438.0	444.0	1000.0	HF	31.0
06425	400/250	273.0	486.0	471.0	1000.0	HF	30.6
06426	400/315	255.5	507.5	516.0	1000.0	HF	33.6
06427	400/400	202.0	564.0	561.5	1000.0	HF	42.9
06430	500/160	247.0	468.0	500.5	1000.0	HF	46.1
06431	500/200	196.0	513.0	509.0	1000.0	HF	46.9
06432	500/250	191.0	521.0	534.5	1000.0	HF	48.9
06433	500/315	148.5	563.5	589.0	1000.0	HF	53.4
06434	500/400	50.5	661.5	662.5	1000.0	HF	60.1
06440	630/160	63.0	644.0	675.0	1000.0	HF	76.5
06441	630/200	34.5	672.5	695.5	1000.0	HF	77.4
06442	630/250	0.0	707.5	718.5	1000.0	HF	79.0
06443	630/315	46.5	707.0	758.0	1000.0	HF	81.5
06444	630/400	Special designs on request				HF	103.9
06445	630/500	Special designs on request				HF	112.9
06446	630/630	Special designs on request				HF	127.0

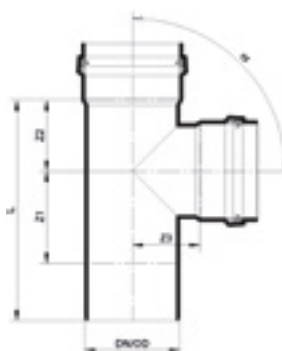

$\alpha=90^\circ$

06455	160/160	138.0	130.0	132.0	364.0	HF	2.0
06458	200/160	126.0	138.0	135.0	383.0	HF	5.4
06459	200/200	136.2	143.0	138.0	398.0	HF	4.2
06462	250/160	402.0	131.0	159.0	680.0	HF	6.9
06464	250/250	358.0	173.0	172.0	680.0	HF	10.7
06467	315/160	317.0	179.5	221.0	680.0	HF	11.1
06470	315/315	264.0	232.0	232.0	680.0	HF	22.3
06473	400/160	607.0	156.0	260.0	1000.0	HF	28.5
06477	400/400	461.0	307.0	293.0	1000.0	HF	44.1
06480	500/160	547.8	164.2	318.9	1000.0	HF	45.5
06485	500/500	365.0	355.0	342.0	1000.0	HF	62.7
06490	630/160	501.5	205.5	374.5	1000.0	HF	76.0
06491	630/200	481.5	225.5	375.0	1000.0	HF	76.4
06492	630/250	456.5	250.5	373.0	1000.0	HF	77.4
06493	630/315	424.0	283.0	380.0	1000.0	HF	79.0
06494	630/400	Special designs on request				HF	84.0
06495	630/500	Special designs on request				HF	89.6
06496	630/630	Special designs on request				HF	112.3

SG ... injection moulding * approximate weights

HF ... hand moulding

** DN/OD – according to EN 476 Dimension Nominal/Outside Diameter

Subject to technical alterations

RANGE OF PRODUCTS

Dimensions in mm

POLO-ECO plus PREMIUM Three-socket-branch made of polypropylene, with inserted lip seal ring, extrusion weld connection	$\alpha=45^\circ$	A. no.	DN/OD**	Z1	Z2	Z3	L	design	kg/pc.*
		06552	160/160	85	221	212	306	HF	2.4
06553	200/160	61	234	256	295	HF	3.7		
06554	250/160	98	309	267	407	HF	9.4		
06555	315/160	56	360	373	417	HF	16.4		
06556	400/160	107	420	432	527	HF	39.2		
06557	500/160	102	477	599	579	HF	44.8		

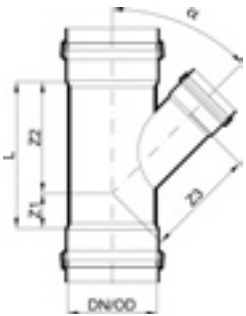

POLO-ECO plus PREMIUM Branch without socket made of polypropylene, with inserted lip seal ring, extrusion weld connection	$\alpha=45^\circ$	A. no.	DN/OD**	Z1	Z2	Z3	L	design	kg/pc.*
		06560	160/160	177	333	254	510	HF	2.8
06561	200/160	175	375	219	550	HF	3.9		
06563	250/160	176	425	319	600	HF	6.0		
06565	315/160	339	662	364	1.000	HF	14.9		

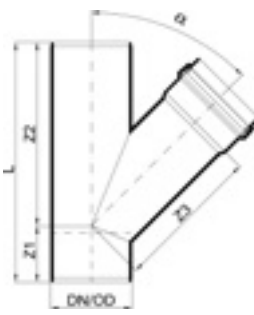

POLO-ECO plus PREMIUM Bottom-level branch made of polypropylene, with inserted lip seal ring, extrusion weld connection	$\alpha=90^\circ$	A. no.	DN/OD1**	DN/OD2**	Z1	Z2	Z3	L	a	b	kg/pc.*
		06571	315	160	317	317	196	1000	52	20	13.56
06572	400	160	317	317	246	1000	82	30	21.96		
06573	500	160	317	317	289	1000	119	40	34.52		
06574	630	160	317	317	354	1000	168	50	58.09		

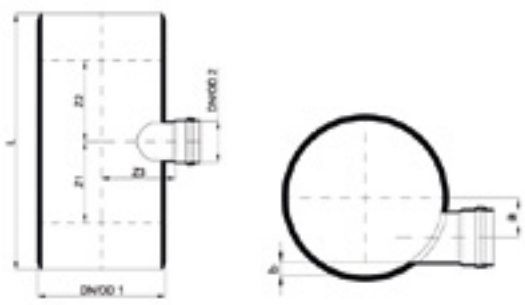

SG ... injection moulding

HF ... hand moulding

* approximate weights

** DN/OD – according to EN 476 Dimension Nominal/Outside Diameter

Subject to technical alterations

GENERAL INFORMATION

MATERIAL CHARACTERISTICS

PRODUCT PERFORMANCE

OPERATIONAL PROPERTIES

RANGE OF PRODUCTS

LAYING INSTRUCTIONS

INVITATION TO TENDER TEXTS

RANGE OF PRODUCTS

Dimensions in mm

GENERAL INFORMATION

POLO-ECO plus PREMIUM Transition pipe

made of polypropylene,
with inserted lip seal ring,
heat reflector weld connection

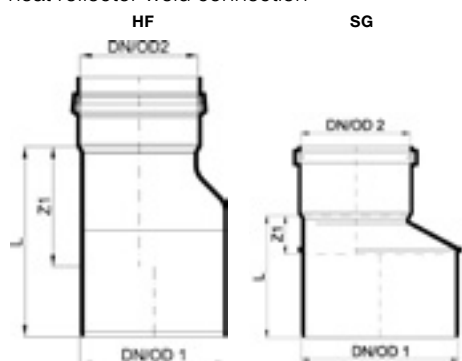

A. no.	DN/OD**	Z1	L	design	kg/pc.*
06500	125/110	18.0	92	SG	0.3
06501	160/110	39.0	124	SG	0.5
06502	160/125	32.0	117	SG	0.5
06503	200/160	55.0	174	SG	1.1
06505	250/200	169.0	321	HF	3.2
06507	315/250	217.0	401	HF	6.5
06509	400/315	279.0	514	HF	13.8
06511	500/400	342.5	580	HF	26.9
06512	630/500	66.5	414	HF	55.7

MATERIAL CHARACTERISTICS

PRODUCT PERFORMANCE

POLO-ECO plus PREMIUM Double socket

made of polypropylene,
with inserted lip seal ring,
heat reflector weld connection



A. no.	DN/OD**	Z1	L	design	kg/pc.*
06530	110	2.8	145	SG	0.3
06531	125	3.5	157	SG	0.4
06532	160	3.6	180	SG	0.6
06533	200	4.0	240	SG	1.5
06534	250	9.0	292	SG	2.2
06535	315	94.0	457	HF	8.2
06538	630	113.0	716	HF	35.2

Use the **double socket** to interconnect two spigot ends when a pipe line is being laid for the first time. The double socket covers nearly every case of application that may occur when sewage pipes are fitted together for the first time.

OPERATIONAL PROPERTIES

POLO-ECO plus PREMIUM Sleeve

made of polypropylene, with inserted
double lip seal rings (DN/OD 160–315) or
lip seal rings (DN/OD 400–500)
extrusion weld

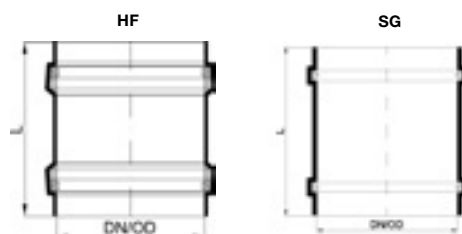

A. no.	DN/OD**	L	design	kg/pc.*
06520	110	145	SG	0.3
06521	125	157	SG	0.4
06522	160	180	SG	0.6
06523	200	240	SG	1.3
06524	250	294	SG	2.1
06525	315	359	HF	5.8
06526	400	465	HF	11.7
06527	500	558	HF	23.4
06528	630	716	HF	34.0

The **sleeve** can be used, if a branch has to be retrofitted or pipes need to be replaced (repair). Mark the length of the sleeve on the spigot ends of the pipe.

RANGE OF PRODUCTS

LAYING INSTRUCTIONS

INVITATION TO TENDER TEXTS

SG ... injection moulding

HF ... hand moulding

* approximate weights

** DN/OD – according to EN 476 Dimension Nominal/Outside Diameter

Subject to technical alterations

RANGE OF PRODUCTS

Dimensions in mm

POLO-EHP control in white for POLO-ECO plus PREMIUM

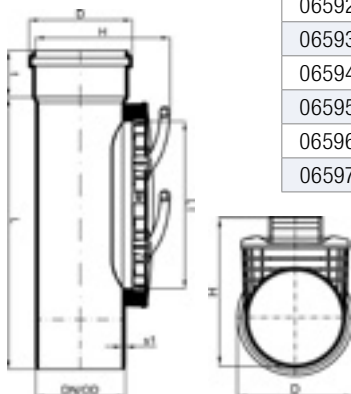

A. no.	DN/OD	L	s1 (min)	t	D	H	L1	design	kg/pc.*
06590	110	468	3.6	65.0	129.0	196	301	SG	2.3
06591	125	474	4.0	73.0	146.5	222	301	SG	2.5
06592	160	488	5.1	84.0	185.0	251	301	SG	3.1
06593	200	518	7.0	120.0	230.5	295	301	SG	4.6
06594	250	680	8.5	150.0	290.0	330	301	HF	8.5
06595	315	680	10.8	180.0	362.5	400	301	HF	13.0
06596	400	1000	13.6	230.0	457.5	485	301	HF	30.0
06597	500	1000	17.1	280.0	571.0	585	301	HF	49.0

GENERAL INFORMATION

MATERIAL CHARACTERISTICS

POLO-ECO plus PREMIUM

Socket plugs

made of polypropylene,
extrusion welded connections

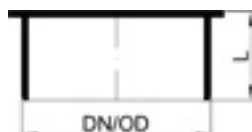

A. no.	DN/OD**	L	design	kg/pc.*
06540	110	62.0	SG	0.1
06541	125	81.0	SG	0.2
06542	160	92.0	SG	0.3
06543	200	122.5	SG	0.8
06544	250	118.0	HF	1.6
06545	315	134.5	HF	2.3
06546	400	115.0	HF	5.6

Preferably use the original plugs for POLO-ECO plus PREMIUM pipes.
The insertion length of socket plugs made of PVC-KG may be too short (L2), which is why leaks might occur.

PRODUCT PERFORMANCE

OPERATIONAL PROPERTIES

RANGE OF PRODUCTS

LAYING INSTRUCTIONS

INVITATION TO TENDER TEXTS

SG ... injection moulding

HF ... hand moulding

* approximate weights

** DN/OD – according to EN 476 Dimension Nominal/Outside Diameter

Subject to technical alterations

RANGE OF PRODUCTS

Dimensions in mm

GENERAL INFORMATION

POLO-ECO plus PREMIUM

Drop branch

made of polypropylene,
with inserted lip sealing ring,
extrusion weld connection

A. no.	DN/OD**	α	Z1	Z2	Z3	L	design	kg/pc.*
06698	160/160	45°	503.6	124.5	339.9	724.0	HF	3.9
06699	200/200	45°	590.8	122.4	347.1	832.2	HF	6.9

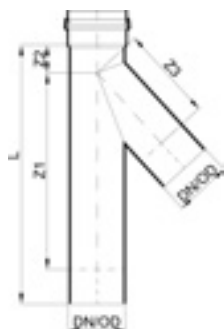

MATERIAL CHARACTERISTICS

PRODUCT PERFORMANCE

Assembly of a drop branch

- If there is a great difference of level between the domestic and the public road sewer, and
- on heavily sloping territory a drop branch needs to be fitted.

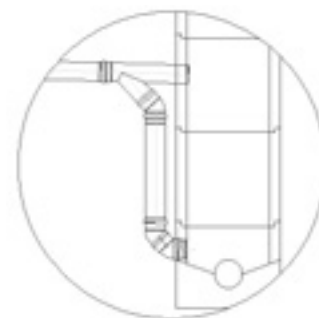
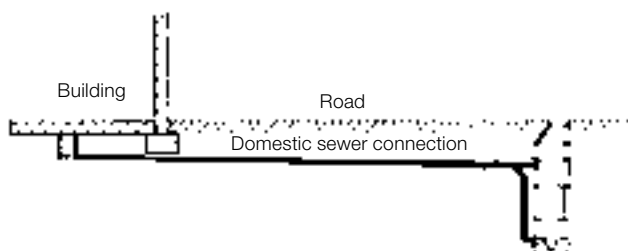

OPERATIONAL PROPERTIES

POLO-ECO plus PREMIUM Transition from stoneware spigot end to POLO-ECO plus PREMIUM socket

A. no.	DN/OD**	L	t	Z	design	kg/pc.*
00877	160	108.0	120.0	12.0	SG	1.1

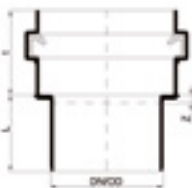

RANGE OF PRODUCTS

LAYING INSTRUCTIONS

INVITATION TO TENDER TEXTS

SG ... injection moulding





HF ... hand moulding

* approximate weights

** DN/OD – according to EN 476 Dimension Nominal/Outside Diameter

Subject to technical alterations

RANGE OF PRODUCTS

POLO-ECO plus PREMIUM Lip ring seal BL for pipes and fittings, except for the slip-on socket 	A. no.	DN/OD**	kg/pc.*
	02934	110	0.02
	02935	125	0.02
	02936	160	0.05
	02937	200	0.07
	02938	250	0.18
	04476	315	0.28
	04477	400	0.42
	04479	500	0.75
	04469	630	1.20
POLO-ECO plus PREMIUM Double lip sealing ring DD for slip-on socket 	A. no.	DN/OD**	kg/pc.*
	02943	110	0.02
	02944	125	0.03
	02945	160	0.07
	02947	200	0.20
	04519	250	0.28
	04520	315	0.30
POLO-ECO plus PREMIUM Lip ring seal BL for slip-on socket 	A. no.	DN/OD**	kg/pc.*
	04477	400	0.42
	04479	500	0.75
	04469	630	1.20
POLO-ECO plus PREMIUM NBR lip ring seal resistant to oil and grease, impermeable to radon 	A. no.	DN/OD**	kg/pc.*
	00152	110	0.02
	00153	125	0.02
	00154	160	0.05
	00155	200	0.07
	00156	250	0.18
	00167	315	0.28
	00168	400	0.42
	00169	500	0.75
	00160	630	1.20

GENERAL INFORMATION

MATERIAL CHARACTERISTICS

PRODUCT PERFORMANCE

OPERATIONAL PROPERTIES

RANGE OF PRODUCTS

LAYING INSTRUCTIONS

INVITATION TO TENDER TEXTS

SG ... injection moulding

HF ... hand moulding

* approximate weights

** DN/OD – according to EN 476 Dimension Nominal/Outside Diameter

Subject to technical alterations

RANGE OF PRODUCTS

GENERAL INFORMATION

5.6 Accessories

POLO Cutting and Chamfering Device

suitable for plastic pipes in the dimensional range of DN/OD 110 to DN/OD 315 mm. The set consists of a shock-proof case, a cutting tool 1200 W with special cutting disc, two roller brackets, a universal marking tape DN/OD 110–DN/OD 630, including felt pen, and a face spanner.

A. no.

05150



MATERIAL CHARACTERISTICS

POLO Cutting and Chamfering Disc

Cutting disc only matching the POLO cutting and chamfering device.

A. no.

05151



PRODUCT PERFORMANCE

OPERATIONAL PROPERTIES

RANGE OF PRODUCTS

LAYING INSTRUCTIONS

INVITATION TO TENDER TEXTS

SG ... injection moulding

HF ... hand moulding

* approximate weights

** DN/OD – according to EN 476 Dimension Nominal/Outside Diameter

Subject to technical alterations

LAYING INSTRUCTIONS

6.1 General information

6.1.1 Fields of application

POLO-ECO plus PREMIUM and POLO-ECO plus PREMIUM RW pipe systems are mainly used in new structures and for the rehabilitation of:

- all mixed-type and separated sewage systems
- sewage systems with a high gradient (high resistance to abrasion)
- sewage systems with a very small gradient (smooth pipe walls, high longitudinal rigidity)
- sewage systems conveying chemically aggressive waste water
- sewage systems with a small height above the pipe vertex
- sewage systems laid at a great depth
- surface water drainage
- pressureless drinking water conveying pipes, such as spring water chambers
- openly laid piping with point-contact support (for example, pipe clamps, bracket supports, etc.)

6.1.2 Applicable standards

The piping needs to be laid according to the recommendations of DIN EN 1610 (laying and testing of waste water and sewage pipes).

For the structural analyses, the EN 1295-1 (General requirements placed on structural analyses of pipe systems), as well as calculation methods recognised in the respective country (for example, ATV-DVWK-A 127 or ÖNORM B5012) apply.

PP sewage pipes and fittings with their standard lip ring seals are suitable for drainage of chemically aggressive waste water with a pH value of 2 (acid) to pH 13 (alkaline) (see DIN 8078, supplement).

6.1.3 Relevant standards

Sewage piping must be laid by experts trained in laying plastic pipes. Among others, the accident prevention regulations issued by the industrial trade associations, the relevant regulations contained in technical rules, the road traffic rules, and, if applicable, special regulations of organisations that are part of the project, need to be observed when pipe systems are laid.

LAYING INSTRUCTIONS

GENERAL INFORMATION
MATERIAL CHARACTERISTICS
PRODUCT PERFORMANCE
OPERATIONAL PROPERTIES
RANGE OF PRODUCTS
LAYING INSTRUCTIONS
INVITATION TO TENDER TEXTS

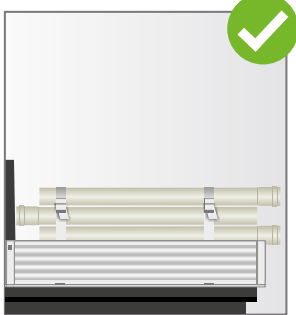
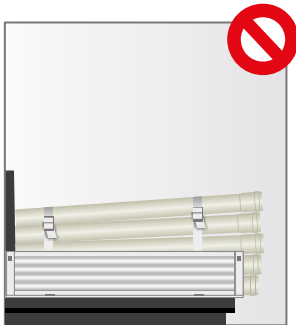

ILLUSTRATION 21



ILLUSTRATION 22

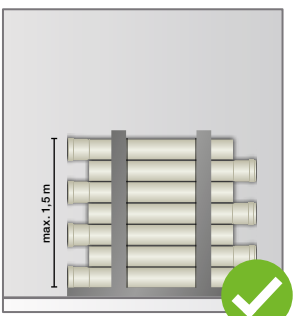
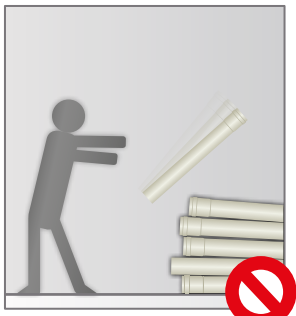

ILLUSTRATION 23

6.2 Transportation and storage

6.2.1 Loading and transportation

When loading pipes and fittings make sure to rule out any possible damage during transportation.

Fasten the pipes thoroughly before transporting them. The supporting posts on the sides must be flat and must not have any sharp edges. For transportation, pipes that are no longer on pallets should be supported over their entire length to avoid sagging. The sockets need to be staggered (refer to Illustration 21).

Pipes on pallets need to be loaded and unloaded using belts, as shown in Illustration 22.

6.2.2 Unloading and storage

Take the necessary care when unloading pipes. Never tilt the pipes to unload them, nor throw them down or pull them over sharp edges (for example, loading boards) (see Illustration 23).

No permanent deformation or damage must occur to the pipes following storage. The storage area should be level. Do not stack unpalletized pipes higher than 1.5 metres. By staggering the sockets, the individual layers of pipe are supported over the entire area. Protect pipe stacks from rolling apart (see Illustration 24).



ILLUSTRATION 24

LAYING INSTRUCTIONS

6.3 Digging the utility trench

6.3.1 Trench depth

The trench depth needs to be calculated based on the dimensions of the sewage pipe, the future operational conditions, the pipe properties and such local conditions as soil properties and combinations of structural and dynamic loads.

Sewage pipes should be laid at such a depth that a minimum height above the pipe vertex of 50 cm is guaranteed in areas with traffic loads (see Illustration 25).

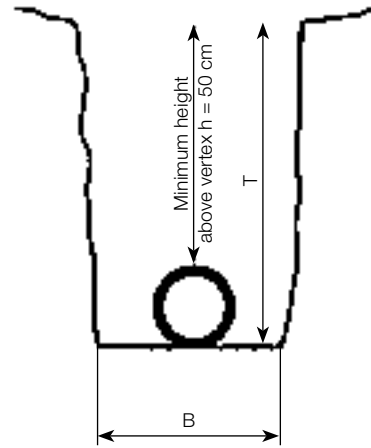

ILLUSTRATION 25

6.3.2 Trench width

The **minimal** trench width measured in the area of the pipe base is indicated in the table below (excerpt from the laying standard EN 1610), unless larger width are required by other regulations:

Trench width in metres

DN/OD**	B	T < 1.00 m	T ≤ 1.75 m	T ≤ 4.00 m	T > 4.00 m
160	B	0.60	0.80	0.90	1.00
200	B	0.60	0.80	0.90	1.00
250	B	0.75	0.80	0.90	1.00
315	B	0.82	0.82	0.90	1.00
400	B	1.10	1.10	1.10	1.10
500	B	1.20	1.20	1.20	1.20
630	B	1.33	1.33	1.33	1.33

T = trench depth

B = trench width

6.3.3 Trench drainage

The ditch bottom must be free from water in order to ensure flawless pipe laying and expert compaction in the laying area. This can be achieved by inserting drainage pits and drainage pipes or water raising installations.

** DN/OD – according to EN 476 Dimension Nominal/Outside Diameter
Subject to technical alterations

LAYING INSTRUCTIONS

GENERAL INFORMATION

6.4 Bedding of the pipe area

6.4.1 Definitions

The terms used are identical with the terms according to the laying standard DIN EN 1610 (see Illustration 26).

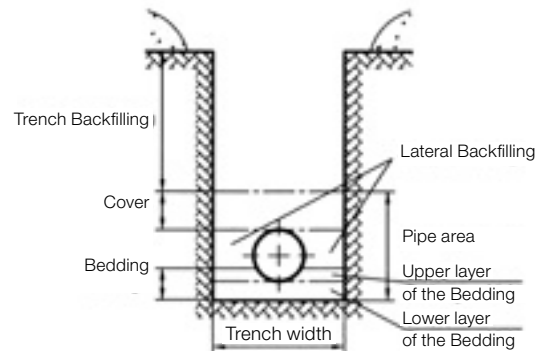

ILLUSTRATION 26

MATERIAL CHARACTERISTICS

6.4.2 Lower layer of the bedding

The lower layer of the bedding needs to be shaped and compacted in accordance with the prevailing gradient. Its thickness must be at least 10 cm, on rocky or compact soil at least 15 cm. The lower bedding layer is part of the pipe support and must ensure as even a distribution of tension as possible. This work needs to be carried out with the corresponding care to rule out punctiform bearing when the pipe is being laid. Recesses need to be prepared in the socket areas (see Illustration 27).

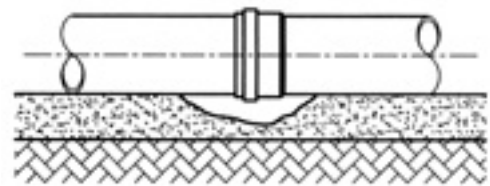

ILLUSTRATION 27

PRODUCT PERFORMANCE

OPERATIONAL PROPERTIES

6.4.3 Upper layer of the bedding

The upper layer of the bedding is also part of the pipe support and needs to be compacted thoroughly. The backfilling of the zone below the pipe towards the sides is very important*. The support angle defines the height of the upper bedding layer. When inserting and compacting the bedding material, make sure not to change the horizontal and vertical position of the pipe.

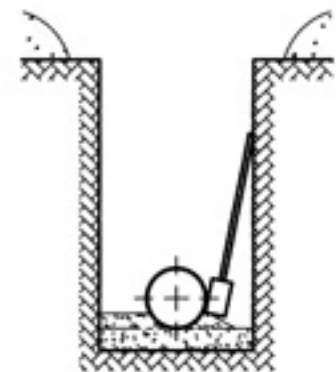

ILLUSTRATION 28

* see Illustration 28

The distribution of pressure around the circumference of the pipe mainly depends on the shape of the pipe support. The support angle is decisive for the proof of dimensional stability. Depending on structural analyses, it is between 120° and 180° (see Illustration 29).

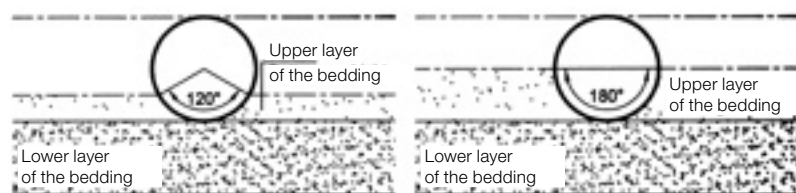

ILLUSTRATION 29

RANGE OF PRODUCTS

LAYING INSTRUCTIONS

INVITATION TO TENDER TEXTS

LAYING INSTRUCTIONS

6.4.4 Lateral backfilling

The lateral backfilling material needs to be inserted on the right and left hand sides of the pipe simultaneously. It supports the pipe in the skewback area, thus minimising vertical deformation. It is very important to provide sufficient compaction against the natural soil

If sheeting panels (trench boxes) are used, the soil needs to be additionally compacted carefully after inserting the sheeting step by step.

6.4.5 Cover

After compaction, the cover height above the pipe vertex must be at least 15 cm (at least 10 cm above the socket connection).

If the soil material contains stones larger than 10 cm, the covering height needs to be increased correspondingly.

6.4.6 Trench backfilling

The backfilling of the trench above the pipe laying area needs to be in accordance with the usage of the corresponding area. Heavy compacting machinery may only be used if the minimum covering soil thickness is 30 cm or higher (after compaction) above the pipe vertex (see Illustration 30). Settlement is only admissible as far as it is technically inevitable. High loads on the soil above the piping during construction, for example, heavy construction machinery or vehicles driving over it, must be avoided.

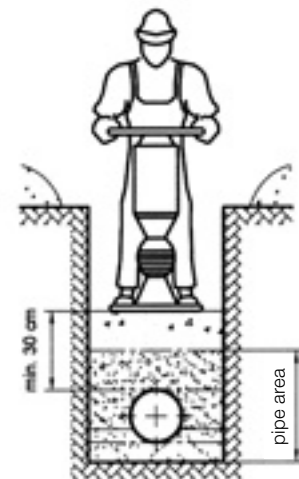

ILLUSTRATION 30

6.4.7 Special designs

If the soil is not stable or larger settling must be expected, special measures, such as soil improvement, replacement, insertion of mesh reinforcement for load distribution purposes, establishment of pile foundations and laying on transverse beams, or similar measures need to be taken.

For special designs, we refer to the plastic pipes laying standards EN 1046.

Note

If branches are used to connect pipes in a vertical direction, these branches must not be positioned immediately on the pipe vertex. First, the branch must be inserted horizontally, and can then be connected vertically (see Illustration 31).

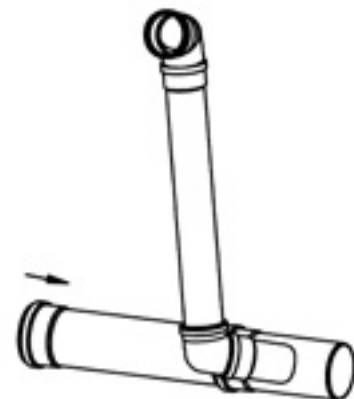

ILLUSTRATION 31

Subject to technical alterations

LAYING INSTRUCTIONS

GENERAL INFORMATION

6.4.8 Bedding material

Establishing the pipe laying area, backfilling the pipe and removing the sheeting, are factors with a major influence on the bearing capacity of the pipe/soil system, which is why this work needs to be carried out thoroughly and in accordance with the design and the structural analysis.

Building materials used in the pipe area must meet the design requirements. These materials may be native soil, provided the suitability was tested before, or building materials supplied to the site.

MATERIAL CHARACTERISTICS

Building materials that are to be used as bedding should not contain any components larger than:

- max. 22 mm for DN/OD \leq 200 mm
- max. 40 mm for DN/OD > 200 mm to DN/OD \leq 630 mm

PRODUCT PERFORMANCE

The native soil and excavated material must meet the following requirements:

- Conformity with the design requirements (soil group, compactability, specific construction measures, etc.) and absence of any frozen particles.
- Absence of material that is detrimental to the pipe (for example, oversize particles, tree roots, lumps of clay, glass)

OPERATIONAL PROPERTIES

Building materials delivered to the site, for example granular, loose materials such as:

- close-range gravel or sand
- wide-range gravel-sand mixes
- one-size gravel (crushed or round)
- mixed grain (all in)
- recycled building materials of different grain size, classified as RS
- "Liquid" soil

RANGE OF PRODUCTS

For more detailed information on bedding and other building materials, please refer to EN 1610.

LAYING INSTRUCTIONS

INVITATION TO TENDER TEXTS

LAYING INSTRUCTIONS

6.5 Cutting to length, bevelling, drilling

Before starting laying, check the pipes and push-fit sockets for possible damage from transportation. Make sure to lay pipes with push-fit sockets in such a way that the push-fit socket is oriented against the direction of flow.

6.5.1 Cutting to length

If necessary, cut the pipes to length at right angles to the pipe axis. Make sure to use suitable tools for cutting the pipes. Remove burrs.

Suitable tools are, for example:

- small angle grinders with removable aluminium abrasive cutting disc (for example, Tyrolit, type No. 739982) or
- large angle grinders with segmented diamond cutting disc (see Illustration 32)

Fittings must not be cut to length.



ILLUSTRATION 32

6.5.2 Bevelling

Bevelling can be done

- using a small angle grinder with removable serrated abrasive disc for smaller pipe dimensions, and
- using a small angle grinder with removable rasp abrasive disc (BOSCH, type No. 2608600180-736) and a serrated disc for finishing, if large pipe dimensions are treated (see Illustration 33).

Bevelling at angles of approximately 15° – 30° according to EN 1610

The remaining wall thickness of the pipe end must at least be one third of the thickness of the pipe end (see Illustration 34).



ILLUSTRATION 33

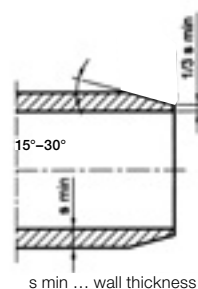

ILLUSTRATION 34

6.5.3 Cutting to length and chamfering in one operation

To perform cutting and chamfering of the pipes in one go, use the POLO cutting and chamfering tool contained in our product list. This tool is suitable for plastic pipes in the dimensional range of DN/OD 110 to DN/OD 315 mm.

A second operation is required for chamfering pipes DN/OD > 315.

1. Use a large angle grinder (refer to Clause 6.5.1) to cut the pipe to the required length.
2. Use the cutting and chamfering tool to chamfer the spigot end.

The set consists of a shock-proof case, a cutting tool 1200 W with special cutting disc, two roller brackets, a universal marking tape DN/OD 110–DN/OD 315, including felt pen, and a face spanner (see Illustration 35).



ILLUSTRATION 35

Subject to technical alterations

GENERAL INFORMATION

MATERIAL CHARACTERISTICS

PRODUCT PERFORMANCE

OPERATIONAL PROPERTIES

RANGE OF PRODUCTS

LAYING INSTRUCTIONS

INVITATION TO TENDER TEXTS

LAYING INSTRUCTIONS

GENERAL INFORMATION

6.5.4 Drilling of POLO-ECO plus PREMIUM Pipes

If pipe drilling boxes are used, drilling can be performed according to the below parameters.

- minimum distance to the socket or spigot end: ≥ 1.00 m
- minimum distance between the bores: ≥ 1.00 m
- no bores opposite one another; minimum distance ≥ 1.00 m
- the location of the bore can be freely selected within the range from 90 to 270°
- use of suitable core bits
- the bore must be deburred

Fittings must **not** be drilled!

When selecting the drilling box, please make sure that it is suitable for being used with plastic pipes with smooth walls and the respective wall thickness of the pipe.

MATERIAL CHARACTERISTICS

PRODUCT PERFORMANCE

6.6 Pipe connections

When the pipe has been cut to the required length and bevelled, preparation for its connection can be started.

OPERATIONAL PROPERTIES

6.6.1 Push-fit socket connections

- Check pipe and sealing ring for damage.
- Remove the lip seal ring, clean the seam and the ring; insert the seal into the seam in the correct position.
- Mark the insertion depth on the pipe end.
- Apply a thin and even layer of POLOPLAST lubricant to the pipe end to be inserted.
- Insert the pipe up to the marking (socket base).
- The pipes need to be pushed together with their axes parallel; this may be done by hand or using a lever. Deflections in the socket zone are not permitted.

The following deflections are admissible:

According to EN476:2011, Clause 6.3.4, in gravity systems, a deflection of the sockets per one metre length, refer to the illustration, of 30 mm for $DN < 300$, of 20 mm for $300 \leq DN \leq 600$, of 10 mm for $600 \leq DN \leq 1,000$ and of $10 \times 1,000/DN$ for $DN > 1,000$, is admissible.

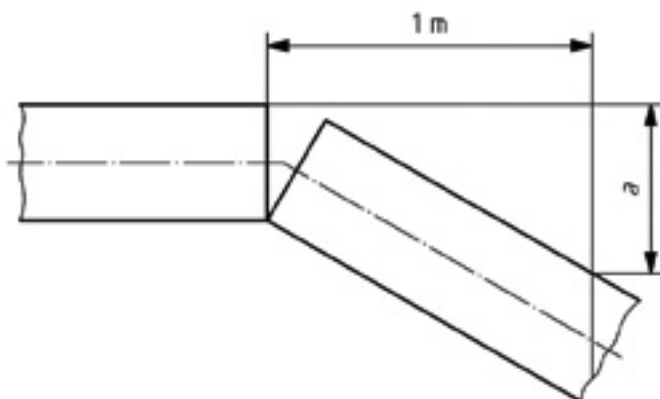

The same applies to fittings.

LAYING INSTRUCTIONS

INVITATION TO TENDER TEXTS

LAYING INSTRUCTIONS

6.6.2 Assembly options for pipes with push-fit sockets

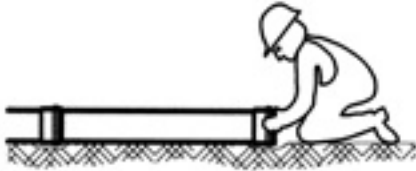

Simple assembly of pipes with small nominal diameters (ILLUSTRATION 36)

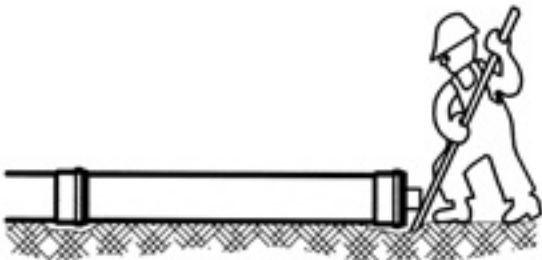

Pushing pipes together using leverage – a wooden pad must be placed (ILLUSTRATION 37)

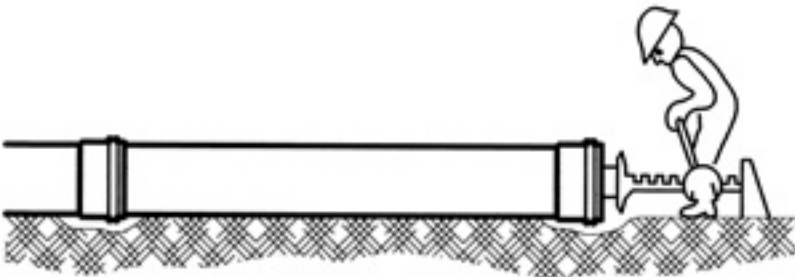

For pipes with large nominal diameters, auxiliary tools and/or laying devices must be used (ILLUSTRATION 38)

INVITATION TO TENDER TEXTS

GENERAL INFORMATION

7.1 Invitation to tender texts

7.1.1 Invitation to tender texts, Austria

POLOPLAST invites you to download Word or pdf files from its download area at www.poloplast.com.

7.1.2 Invitation to tender texts, Germany

With immediate effect, the tender texts for all POLOPLAST products are available on the platform: www.ausschreiben.de.

This makes it easier than ever for you to transfer your texts into bills of quantities and offers – always up-to-date, not depending on manual updates.

This platform is free of charge and offers you the modern option of exporting your tender into various file formats, for example, into GAEB, PDF or Doc.

Many modern AVA software applications and programs for craftsmen offer direct access to www.ausschreiben.de. In this way, the service items can be accepted directly using the drag & drop feature.

Along with the POLOPLAST-specified texts, you can also find our “neutral” invitation-to-tender texts without a manufacturer indicated.

Straightforward access to the on-line tender texts in the download area at: www.poloplast.com:

MATERIAL CHARACTERISTICS

PRODUCT PERFORMANCE

OPERATIONAL PROPERTIES

RANGE OF PRODUCTS

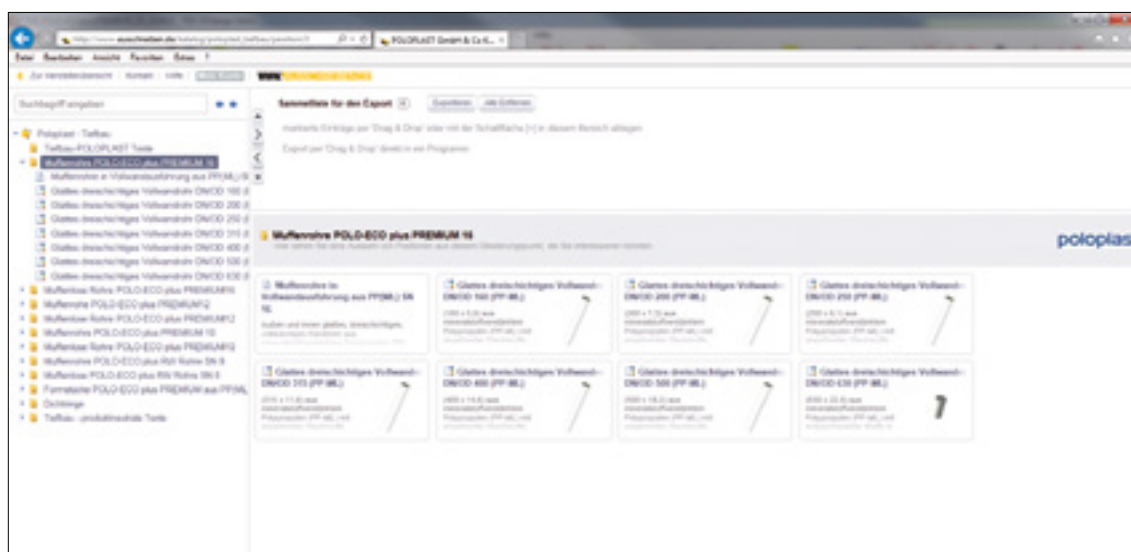

7.1.3 Invitation to tender texts, other formats

Do you need the invitation-to-tender texts in a particular format, or do you have any questions? Do not hesitate to contact your POLOPLAST field contact, or contact POLOPLAST Leonding directly.

INVITATION TO TENDER TEXTS

NOTES

Lined writing area consisting of multiple horizontal lines for notes.

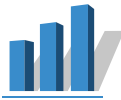

POLOPLAST. A company of **Wietersdorfer**

© Copyright. All contents and graphical representations are protected by copyright and, even in altered form, they may only be reproduced, published or distributed following the express written approval of POLOPLAST.

02/04.18/500_EN_wanted.co.at

PURE
PROGRESS / **poloplast**

POLOPLAST GmbH & Co KG
Poloplaststraße 1
4060 Leonding . Austria
T +43 (0) 732 . 38 86.0 . F +43 (0) 732 . 38 86.9

office@poloplast.com
www.poloplast.com