

MULTICUT SEWAGE PUMPS

- Reliable solids transport due to improved cutting technology
- External adjustable cutting mechanism
- Controllable oil chamber
- SiC mechanical seal independent of sense of rotation
- Moisture-sealed cable inlet with plug-in cable connection
- Installed motor protection



DESCRIPTION

Centrifugal submersible sewage pumps fitted with the MultiCut cutting system are used as stationary appliances in pressurised drainage systems for discharge in sparsely populated areas or of detached houses. They are suitable for pumping domestic wastewater with the usual additions (as specified in German standard DIN 1986, Part 3).

For pumping from ducts which are connected to the public sewer system, explosion-proof submersible pumps of the UFK series have to be used. On account of the upstream cutting system, the pressurised line as from DN 32 - as from DN 80 minimum without cutting system - may be routed parallel to the terrain.

Operating conditions up to a temperature of the material to be transported of 40° Celsius

Submerged motor: Continuous operation (S1)

Emerged motor: Intermittent operation (S3) (e.g. 20% = 2 min. operation, 8 min. break)

The unique MultiCut cutting system ensures a maximum of operational safety at outstanding delivery characteristics. Fitted with a cutter plate made of hardened stainless steel and a three-bladed knife, it disintegrates coarse additions in the wastewater with more than 200,000 cutting processes per minute before they can get into the pump hydraulics. Solids which cannot be transported are rejected outside of the pump by the cutting rotor as the cutting system is located upstream from the pump hydraulics. Specifically arranged grooves on the cutter plate ensure additional safety as the cutting unit is permanently cleaned automatically during the delivery.

PERFORMANCE

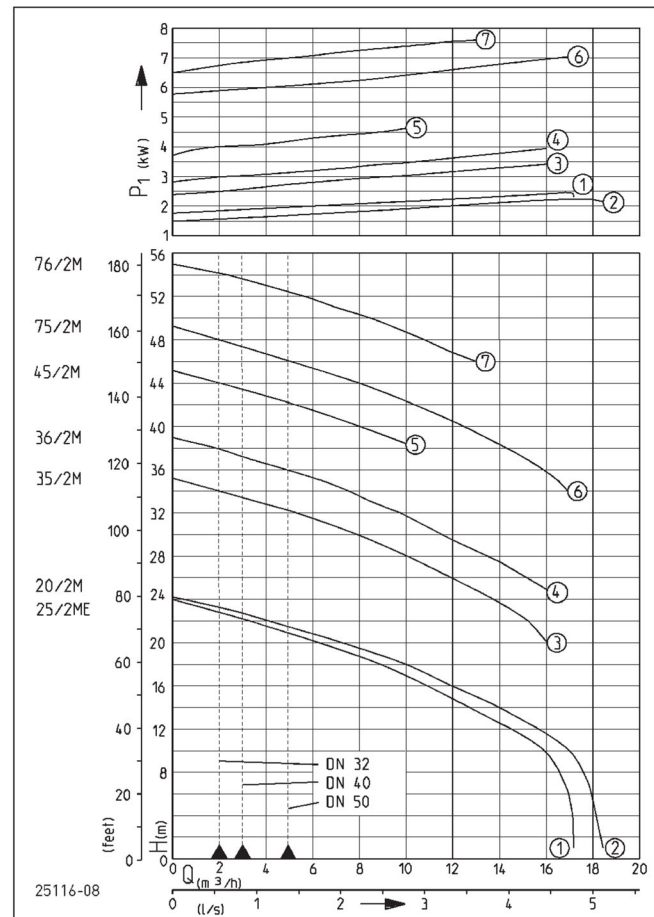

Type	Delivery head H [m]	6	9	12	15	18	21	25	28	32	34	36	38	40	44	46	48	50	52	54
20/2 M plus	Flow rate Q [m³/h]	18	17	16	13	10	6													
25/2 ME		17	16	15	12	9	5													
35/2 M							16	13	10	5										
36/2 M								16	14	10	7	5	2							
45/2 M													10	8	2					
75/2 M											17	16	15	13	8	5	2			
76/2 M																13	11	9	6	3

We reserve the right to change specifications without notice. Pump performance is subject to ISO 9906 tolerances

The minimum flow velocity in the pressure piping must be 0.7 m/s according to EN 12056. This data is represented in the performance curve as a limit of application.



MULTICUT

SEWAGE PUMPS

SCOPE OF SUPPLY

Sewage pump with or without explosion-proof in keeping with German/European standard EN 12050 with 10 m cable, without plug, without base.

Ex II 2 G Ex d IIB T4

(20/2 M: Ex II 2 G Ex d IIB T4 Gb)

Special technical note for 25/2 ME:

As the rated output of the motor exceeds 1.4 kW, the permission of the local power supply organisation has to be obtained prior to ordering and commissioning.

A soft starting device (starting current approx. 33A) can only be installed in the contro unit AD 12 ExME if a new order is placed in the factory.

MECHANICAL DATA

Pump	Vertical single-stage	Run dry protection	Yes
Bearing	Ball bearings, grease-lubricated	Impeller	Vortex impeller, grey cast iron 20/2 M: GFK
Seal on motor side	Duplex shaft seal, from 75/2M: mechanical seal	Motor housing	Grey cast iron
Oil chamber	Yes	Pump housing	Grey cast iron
Seal on medium side	SiC mechanical seal	Submersible	Yes
		Pressure outlet	DN 32

ELECTRICAL DATA

Power line	10m H07RN-F	Insulation class	F
Wires	6G1,5 (ab 55 10G2,5)	Winding thermostat	Yes
Type of enclosure	IP 68	Motor protection	Thermostat

MULTICUT

Type	Code No.	Voltage	Motor rating		Current	Fuse	S3	Weight
			P1	P2				
Without ex-proof								
20/2 M plus	JP50350	3/PE~400 V	2.40 kW	1.91 kW	4.0 A	10 A	25 %	29.0 kg
25/2 ME	JP50356	1/N/PE~230 V	2.70 kW	2.04 kW	12.0 A	16 A	35 %	38.0 kg
35/2 M	JP50357	3/PE~400 V	3.70 kW	3.04 kW	6.6 A	10 A	40 %	40.5 kg
36/2 M	JP50363	3/PE~400 V	4.20 kW	3.42 kW	7.3 A	10 A	30 %	40.5 kg
45/2 M	JP50369	3/PE~400 V	4.84 kW	3.93 kW	7.9 A	10 A	25 %	42.0 kg
75/2 M	JP50375	3/PE~400/690 V	7.70 kW	6.60 kW	13.2 A/7.7 A	20 A	30 %	90.0 kg
76/2 M	JP50377	3/PE~400/690 V	7.70 kW	6.60 kW	13.2 A/7.7 A	20 A	30 %	90.0 kg
With ex-proof								
20/2 M plus, Ex	JP50352	3/PE~400 V	2.40 kW	1.91 kW	4.0 A	10 A	25 %	29.0 kg
25/2 ME, Ex	JP50355	1/N/PE~230 V	2.70 kW	2.04 kW	12.0 A	16 A	35 %	38.0 kg
35/2 M, Ex	JP50359	3/PE~400 V	3.70 kW	3.04 kW	6.6 A	10 A	40 %	40.5 kg
36/2 M, Ex	JP50365	3/PE~400 V	4.20 kW	3.42 kW	7.3 A	10 A	30 %	40.5 kg
45/2 M, Ex	JP50371	3/PE~400 V	4.84 kW	3.93 kW	7.9 A	10 A	25 %	42.0 kg
75/2 M, Ex	JP50376	3/PE~400/690 V	7.70 kW	6.60 kW	13.2 A/7.7 A	20 A	30 %	90.0 kg
76/2 M, Ex	JP50378	3/PE~400/690 V	7.70 kW	6.60 kW	13.2 A/7.7 A	20 A	30 %	90.0 kg

MULTICUT

SEWAGE PUMPS

Dimensions pump base (mm)

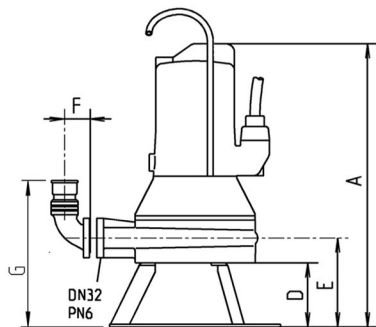

1 1/4"
1 1/4"-1 1/2"

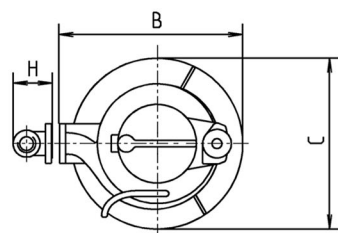

Typ	A	B	C	D	E	F	G	H
20/2M	440	290	230	100	140	60	230	90
25/2ME	520	330	250	140	180	60	270	90
35/2M+36/2M	520	330	250	140	180	60	270	90
45/2M	520	330	255	140	180	60	270	90
75/2M+76/2M	665	430	400	150	210	60	300	90

22625-09

Example of guide rail installation (mm)

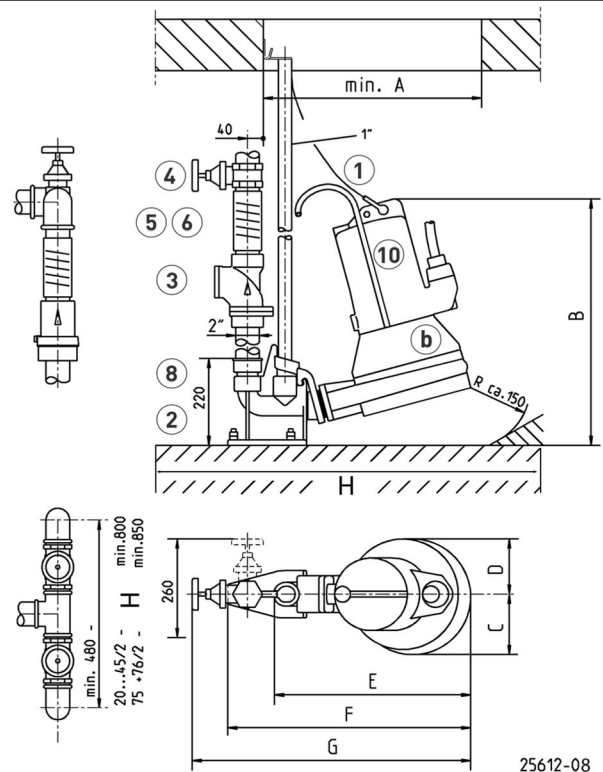

25612-08

	A	B	C	D	E	F	G	H	min.
20/2M plus	430	450	110	110	380	500	585	400 x 700mm	
25/2ME-36/2M	470	490	125	125	420	540	635	400 x 700mm	
45/2M	470	490	130	125	420	540	635	400 x 700mm	
75/2M+76/2M	545	625	155	140	500	615	705	400 x 800mm	

MECHANICAL ACCESSORY



1 Chain

certified, 2.5 m, 320 kg, 5 rings (EN 818 mod.)
certified, 5.0 m, 320 kg, 8 rings (EN 818 mod.)
certified, 7.5 m, 320 kg, 11 rings (EN 818 mod.)
Shackle, certified, 630 kg, stainless steel
Pump hanging (08 Ex - 100...)

Code No.

JP45901
JP45902
JP47365
JP45904
JP45925

2 Guide rail system









GR 35
Guide rail 1" 1500 mm
Guide rail 1" 2000 mm
Guide rail 1" 2500 mm
Guide rail 1" 3000 mm

JP14094
JP48937
JP48938
JP48939
JP48940



MULTICUT

SEWAGE PUMPS

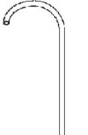
MECHANICAL ACCESSORY

				Code No.
	3 Swing-type check valve			
	R40 EN 12050-4	1½" (DN 40), PN 4	150x120 (HxB)	JP00317
	R50 EN 12050-4	2" (DN 50), PN 4	150x120 (HxB)	JP00326
	Ball-type check valve			
	KE40 EN 12050-4	1½" (DN 40), PN 6	170x125 (HxB)	JP47974
	K50 EN 12050-4	2" (DN 50), PN 6	185x155 (HxB)	JP44782
	4 Stop valve	brass, 1½" (DN 40), PN 16	125x60 (HxB)	JP44786
		stainless steel, 1½" (DN 40), PN 16	125x80 (HxB)	JP48403
		brass, 2" (DN 50), PN 16	140x70 (HxB)	JP44787
	5 Elastic connection	1½" (DN 40), PN 4	120x50 (HxD)	JP44777
		2" (DN 50), PN 4	150x63 (HxD)	JP44775
	6 Hose band clamp	1½"		JP44763
		2"		JP44764
	7 Pump base		20/2M	JP44759
		M	25/2ME - 45/2M	JP20980
		M 220	75/2M - 76/2M	JP22302
	Retaining plate	in connection with startic-air level control		JP23100
	8 Reducing socket	1¼"-1½"		JP44769
		1¼"-2"		JP44772
		1 1/2"-2" for guide rail system GR 35		JP44776
	9 Pipe connection	1 1/4" (female thread)		JP16870
	10 Flushing tube	Type 0	08 Ex, 20/2	JP45408
		Type I	10/... - 45/...	JP28221
		Type II	55/... - 100/...	JP28222

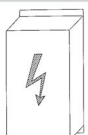

ELECTRICAL ACCESSORY

				Code No.
	a Control for single units			
	Control unit AD 12 ExME, TLS	25/2 ME		JP43163
	soft starting device			JP24138
	Control unit AD 46 ExM, TLS	20/2 M		JP43160
	Control unit HIGHLOGO 1-46 LC			JP47985
	Control unit AD 610 ExM, TLS	35/2 M - 45/2 M		JP43161
	Control unit HIGHLOGO 1-610 LC			JP47986
	Control for duplex units			
	Control unit BD 46 ExM, TLS	20/2 M		JP43166
	Control unit HIGHLOGO 2-46 LC			JP47994
	Control unit BD 610 ExM, TLS	35/2 M - 45/2 M		JP43167
	Control unit HIGHLOGO 2-610 LC			JP47995
	Rechargeable battery	for mains independent alarm		JP44850

MULTICUT

SEWAGE PUMPS

ELECTRICAL ACCESSORY

			Code No.
	b Seal leak detector	DKG	JP44900
		DKG Ex for explosion-proof pumps	JP00249
	Smart Home	FTJP radio transmitter	JP47209

MULTICUT

SEWAGE PUMPS